

السادة أعضاء جمعية رجال الأعمال المصريين الأفارقة المحترمين

استكمالاً للجهود المستمرة والعلاقات المتميزة التي تربط الجمعية بشركائها الاستراتيجيين، وحرصاً على تعزيز التعاون مع الجهات الخارجية وفتح آفاق جديدة أمام مجتمع الأعمال المصري، يسرنا أن نُقدّم لأعضاء الجمعية شركة Kamvol، إحدى أبرز شركات النسيج في بيلاروسيا وأوروبا، والتي تأسست عام 1955 ومنذ ذلك الحين وهي تواصل تطوير منتجاتها لتصبح من أكبر الشركات في مجال الأقمشة والخامات الصناعية في بيلاروسيا ودول رابطة الدول المستقلة (CIS)، حيث تقدم إنتاجاً متنوعاً يركز على نوعين رئيسيين: أقمشة الصوف الفاخرة عالية الجودة للأسواق الأوروبية الراقية، والخامات الصناعية الثقيلة والمتخصصة التي تشمل أقمشة الخيام (Tent / PVC fabrics)، ومواد تهوية المناجم، وعوازل الأسطح (Roofing membranes)، ومواد مقاومة للمياه (Waterproofing)، بالإضافة إلى الأقمشة التقنية والزخرفية، مع اعتمادها على تكنولوجيا متطورة في معالجة الألياف لضمان جودة عالية وفعالية في الاستخدام، ما يجعل التعاون معها فرصة حقيقية لتوسيع نطاق الأعمال المصرية وفتح أسواق جديدة في أوروبا وبيلاروسيا.

مرفق مع المنشور

وتفضلوا بقبول فائق الاحترام،

رئيس مجلس إدارة جمعية
رجال الأعمال المصريين الأفارقة

د/ يسري الشراوي

جمعية رجال الأعمال المصريين الأفارقة
مشهرة برقم ١١٤٥٥ لسنة ٢٠٢٠
Egyptian African Businessmen's Association
6779/2020

الأمين العام لجمعية
رجال الأعمال المصريين الأفارقة

م / مصطفى الامير

JSC «RUCHAIKA»

PVC TENT MATERIAL



JSC «RUCHAIKA» TODAY

- PRODUCES **TENT MATERIALS**, ROOFING MEMBRANE, MATERIALS FOR MINE VENTILATION, TECHNICAL AND DECORATIVE FABRICS, GEOTEXTILES, FINISHED PVC TENT PRODUCTS.
- MORE THAN 60% OF THE COMPANY'S PRODUCTS ARE EXPORTED TO THE CIS COUNTRIES, NEAR AND FAR ABROAD

ABOUT US

ruchaika.by

ABOUT US

- THE ONLY IN THE REPUBLIC OF BELARUS AND ONE OF THE LARGEST IN THE CIS MANUFACTURER OF TENT MATERIALS, MATERIALS FOR MINE VENTILATION, ROOFING MEMBRANE AND WATERPROOFING MATERIALS.
- ONE OF THE LARGEST CIS MANUFACTURERS OF TECHNICAL AND DECORATIVE FABRICS, TENT BACKING FABRICS.

ABOUT US

TENT MATERIAL



TENT MATERIAL

PRODUCT RANGE

- THE PRODUCTION CYCLE OF TENT MATERIAL CONSISTS OF THE FOLLOWING STAGES: WEAVING OF BASES, APPLICATION OF PVC COMPOSITION. TENT MATERIAL CAN BE PRODUCED IN VARIOUS DENSITIES: FROM 450 TO 1300 G/M² WITH DIFFERENT CHARACTERISTICS.
- PRODUCTION OF PVC MATERIALS IS CARRIED OUT ON MODERN EQUIPMENT OF ISOTEX (ITALY).

TENT MATERIAL

TENT MATERIAL

- 1 - reinforcing fabric**
- 2 - base coat**
- 3 - PVC coating**
- 4 - varnish**

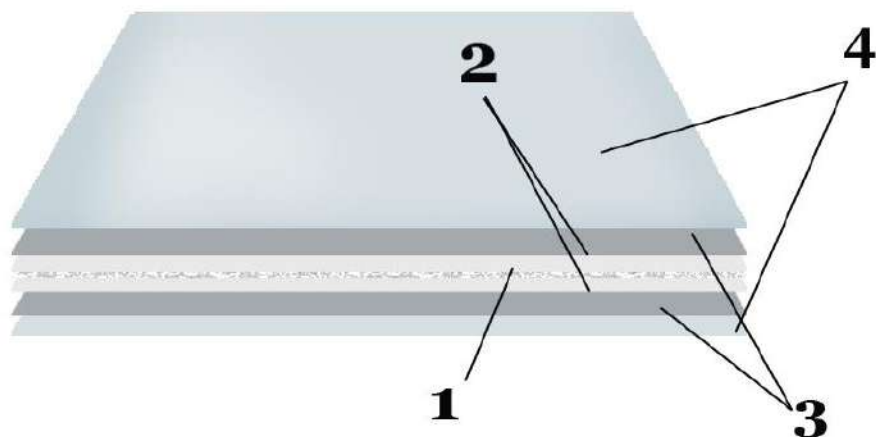

TENT MATERIAL

PRODUCT RANGE

TENT MATERIAL

- TENT MATERIAL "RUCHAIKA" IS A THREE-LAYER PVC MATERIAL. THE BASIS OF THE MATERIAL IS A FABRIC MADE OF POLYESTER TECHNICAL THREADS. THE BASE IS COATED ON BOTH SIDES WITH A PVC COMPOSITION, ADDITIONALLY IT CAN BE VARNISHED ON ONE OR TWO SIDES.
- PVC RESIN GIVES THE MATERIAL DURABILITY. THE MATERIAL HAS EXCELLENT LIGHT FASTNESS.



ruchaika.by

TENT MATERIAL



TENT MATERIAL

PRODUCT RANGE

TENT MATERIAL

APPLICATION OF PVC TENT MATERIALS

- PRODUCTION OF ARCHITECTURAL AND FRAME STRUCTURES, FRAME TENT STRUCTURES, LARGE HANGARS, LARGE SHEDS, OUTDOOR CAFES, PAVILIONS, TEMPORARY STORAGE WAREHOUSES;
- PRODUCTION OF CAR COVERS, HANGARS, INFLATABLE BOATS, INFLATABLE TRAMPOLINES, ATTRACTIONS, TUBING (CHEESECAKES);
- FOR CANOPIES, CURTAINS, SHELTERS AND OTHER TECHNICAL PURPOSES.

THE RANGE OF TENT MATERIALS



TENT MATERIAL

TENT MATERIAL

PRODUCT RANGE

TENT MATERIAL

- FOR CURTAINS, BLINDS WITHOUT LACQUER
- FOR CAR COVERS, WITH ONE-SIDED LACQUER
- FOR ARCHITECTURAL AND FRAME STRUCTURES WITH 2-SIDED LACQUER
- FOR ARCHITECTURAL AND FRAME STRUCTURES WITH 2-SIDED LACQUER. FROST-RESISTANT (UP TO 50 °C)
- FOR ARCHITECTURAL AND FRAME STRUCTURES WITH 2-SIDED LACQUER. FIRE-RESISTANT (G1-G2)



TENT MATERIAL



FOR CURTAINS, BLINDS WITHOUT LACQUER

TENT MATERIAL

PRODUCT RANGE

- IT IS DESIGNED FOR THE MANUFACTURE OF CURTAINS, BLINDS, SHELTERS AND OTHER TECHNICAL PURPOSES. IT HAS A LIGHT WEIGHT MASS.

ADVANTAGES:

- - MATERIAL OPTIMALLY COMBINES LIGHTNESS, STRENGTH AND ELASTICITY;
- - WATERPROOF;
- - NON-TOXIC;
- - RESISTANT TO PETROL AND OILS
- - RESISTANT TO TEMPERATURE CHANGES FROM - 30°C UP TO +70°C.

TENT MATERIAL

TECHNICAL SPECIFICATIONS



MATERIAL FOR CURTAINS, BLINDS

TENT MATERIAL

PRODUCT RANGE

TENT MATERIAL

	Index	Value			
1	Weight of 1m ² , g	500	550	600	630
2	Breaking load (20x100) mm, N	950	1000	1050	1200
	- warp	750	800	850	850-950
3	Resistance to tearing, N	200	250	270	280
	- warp	200	250	260	270
4	Elongation at break, %	15-40			
	- warp	20-40			
5	Temperature resistance, the lower limit, C	-30			
6	Temperature resistance, the upper limit, C	+70			
7	Fire resistance, mm / min	100			
8	Adhesion, N / 50m	80	100	80-100	80-100
9	Roll length, m, ±2,5 cm	50-65			
10	Roll width, m, ±2,5 cm	2,5-3,2			

TENT MATERIAL



**FABRICS FOR CAR COVERS
(ONE-SIDED VARNISHING)**

TENT MATERIAL

PRODUCT RANGE

TENT MATERIAL

- IT IS DESIGNED FOR THE MANUFACTURE OF CAR COVERS, FRAME TENT STRUCTURES, HANGARS, INFLATABLE TRAMPOLINE, RIDES, TUBING (CHEESECAKES) AND OTHER TECHNICAL PURPOSES.

THE ADVANTAGES:

- - MATERIAL OPTIMALLY COMBINES LIGHTNESS, STRENGTH AND ELASTICITY;
- - WATERPROOF;
- - NON-TOXIC;
- RESISTANT TO PETROL AND OILS;
- - RESISTANT TO TEMPERATURE CHANGES FROM -30°C UP TO $+70^{\circ}\text{C}$;
- - FROST RESISTANCE TO -60°C ;
- - ABILITY TO PRINT WITH SOLVENT INK ON THE TENT;
- - ROLL WIDTH 3,2 M;
- - IT IS POSSIBLE TO PRODUCE MATERIALS MEETING ALL PHYSICAL AND MECHANICAL PROPERTIES APPLIED BY THE CUSTOMER
- - RICH COLORS.

TECHNICAL SPECIFICATIONS



FABRICS FOR CAR COVERS

TENT MATERIAL

PRODUCT RANGE

TENT MATERIAL

	Index	Value				
1	Weight of 1m2, g	600	630	650	750	900
2	Breaking load (20x100) mm, N	1050	1100-1200	1100-1200	1200	1500
	- warp	850	850-950	900-1000	1100	1200
3	Resistance to tearing, N	270	280	290	270	500
	- warp	260	270	290	260	400
4	Elongation at break, %	15-40				
	- warp	20-40				
5	Temperature resistance, the lower limit, C	-30				
6	Temperature resistance, the upper limit, C	+70				
7	Fire resistance, mm / min	100				
8	Adhesion, N / 50m	80-100	80-100	90-100	80-100	100
9	Roll length, m, ±2,5 cm	65	50-65	50-65	50-65	50
10	Roll width, m, ±2,5 cm	2,5	2,5-3,2	2,5-3,2	2,5-3,0	3,0

TENT MATERIAL



**MATERIAL FOR ARCHITECTURAL AND
FRAME STRUCTURES**

TENT MATERIAL

ruchaika.by

PRODUCT RANGE

- IT IS DESIGNED FOR THE MANUFACTURE OF ARCHITECTURAL AND FRAME STRUCTURES, FRAME TENT STRUCTURES, LARGE SHEDS, OUTDOOR CAFES, PAVILIONS, TEMPORARY STORAGE WAREHOUSES, AND OTHER INDUSTRIAL PURPOSES.

ADVANTAGES:

- - MATERIAL OPTIMALLY COMBINES LIGHTNESS, STRENGTH AND ELASTICITY;
- - WATERPROOF;
- - NON-TOXIC;
- - RESISTANT TO PETROL AND OILS;
- - TEFLON COATING WITH PVDV VARNISH INCREASES RESISTANCE TO UV RADIATION AND INCREASES THE SERVICE LIFE;
- - RESISTANT TO TEMPERATURE CHANGES FROM -30°C UP TO $+70^{\circ}\text{C}$;
- - FROST RESISTANCE TO -60°C ;
- - RESISTANCE TO COMBUSTION BY "FIRE-SAFE" - G1 AND G2;
- - ABILITY TO PRINT WITH SOLVENT INKS.

TENT MATERIAL



TECHNICAL SPECIFICATIONS



**MATERIAL FOR ARCHITECTURAL AND
FRAME STRUCTURES**

ruchaika.by

TENT MATERIAL

PRODUCT RANGE

TENT MATERIAL

	Index	Value			
1	Weight of 1m2, g	630	650	750	900
2	Breaking load (20x100) mm, N - warp - weft	1100-1200 850-950	1100-1200 900-1000	1200 1100	1500 1200
3	Resistance to tearing, N - warp - weft	280 270	290 290	270 260	500 400
4	Elongation at break, % - warp - weft	15-40 20-40			
5	Temperature resistance, the lower limit, C	-30			
6	Temperature resistance, the upper limit, C	+70			
7	Fire resistance, mm / min	100			
8	Adhesion, N / 50m	90	90	90	100
9	Roll length, m, $\pm 2,5$ cm	50-65		50	
10	Roll width, m, $\pm 2,5$ cm	2,5-3,2		3,0	



WELDING RECOMMENDATIONS



TENT MATERIAL

TENT MATERIAL

PRODUCT RANGE

TENT MATERIAL

	Density	Machine	Welding speed	Welding temperature
1	MT, МТМП-450	LEISTER UNIPLAN E	4,7-5 m/min	620 C°
2	MT, MT1, MT2-500	LEISTER UNIPLAN E	4,7-5 m/min	620 C°
3	MT-550	LEISTER UNIPLAN E	4,7 m/min	620 C°
4	MTM, МТП-550	LEISTER VARIMAT	4,0 m/min	620 C°
5	MT, MT1-600	LEISTER UNIPLAN E	4,5-5 m/min	620 C°
6	MT, MT1, MT2 – 630-650	LEISTER UNIPLAN E	4,5-5 m/min	620 C°
7	MTM, МТМ1, МТП, МТП1, МТМП- 630-650	LEISTER VARIMAT	4,5-4,7 m/min	620 C°
8	МТЛ-630	LEISTER UNIPLAN E	6-7 m/min	620 C°
9	MT1, MT2, МТП1, МТМ1, МТМП1- 750	LEISTER UNIPLAN E	on request for testing	620 C°
10	MT1, MT2, МТМ, МТМ1, МТП1, МТМП1, МТП2, МТМП2-900	LEISTER VARIANT T1	4,2-4,5 m/min	620 C°
11	MT2-1100	LEISTER VARIMAT	on request for testing	620 C°
12	MT, MT2-1300	LEISTER VARIMAT	on request for testing	620 C°
13	МТП2-1350	LEISTER VARIMAT	on request for testing	620 C°

TENT MATERIAL «RUCHAIKA»



TENT MATERIAL

PRODUCT RANGE

TENT MATERIAL

ADVANTAGES

- OPTIMALLY COMBINES THE RELIABILITY, STRENGTH AND ELASTICITY;
- NON-TOXIC, NO ADVERSE EFFECTS ON THE HUMAN BODY;
- POSSIBILITY TO MANUFACTURE MATERIALS IN ACCORDANCE WITH ALL PHYSICAL AND MECHANICAL PROPERTIES APPLIED BY THE CUSTOMER;
- RESISTANT TO PETROL AND OILS;
- ABILITY TO PRINT WITH SOLVENT INK ON THE TENT;
- WIDE RANGE OF COLORS ACCORDING TO THE CATALOG RAL COLORS OR AS AGREED WITH THE CUSTOMER;
- WIDTH OF ROLLS CAN BE FROM 2,5 M TO 3,2 M.

CERTIFICATES



ABOUT THE COM

TENT MATERIAL

ABOUT THE COMPANY

- THE HIGH LEVEL OF ORGANIZATION OF MATERIAL'S PRODUCTION, CONFIRMED BY A CERTIFICATE OF CONFORMITY OF QUALITY MANAGEMENT SYSTEM STB ISO 9001-2009. YEARS OF EXPERIENCE, QUALIFIED PERSONNEL, EFFICIENT USE OF PROCESSING EQUIPMENT, COOPERATION WITH DOMESTIC AND FOREIGN BUSINESS PARTNERS, ALLOW THE COMPANY TO PRODUCE A WIDE RANGE OF HIGH QUALITY TEXTILE AND TECHNICAL MATERIALS.

- IN 2013, 2015, 2018, 2021 AS A RESULT OF THE CONCLUSION OF THE EXPERT COUNCIL TENT AND ROOFING MATERIAL MANUFACTURED BY JSC "RUCHAIKA" WON THE CONTEST IN THE NOMINATION "THE BEST BUILDING MATERIAL (PRODUCT) OF THE YEAR".



JSC «RUCHAIKA»



TENT MATERIAL

CONTACT DETAILS

ruchaika.by

CONTACT US TO DISCUSS TERMS



www.ruchaika.by



139-7 Sovetskaya str.
Brest region, Kobrin
225304, Republic of Belarus



+375 1642 3 44 06
+375 33 637 18 36
+375 29 692 24 73



market@ruchaika.by

CONTACT DETAILS

JSC «RUCHAIKA»

QUALITY TRADITIONS. MODERN TECHNOLOGY.



POLE ǨVETAK
by Orsha Linen Mill

ORSHA LINEN MILL

**COTTONIZED
LINEN FIBER**

www.linenmill.by



- Cottonization is one of the most modern and promising ways of processing short flax fiber. The launch of Temafa (Germany), Rieter (Switzerland) and Laroche (France) cottonization lines made it possible to start producing cottonized linen fiber, which is widely used as a raw material in various industries, for example in blended yarns and non-woven materials production. The cottonization chain is fully automated and consists of a modular system of opening and cleaning stages in which fibers are gradually cleaned, separated and shortened. Cottonized linen fiber has purity similar to cotton fiber. ●

www.linenmill.by



TYPES OF COTTONIZED LINEN FIBER



Co III bleached

Already bleached fiber makes it possible to be used in further production, thereby reducing its cost.



Co III natural



Co III boiled

The process of boiling destroys pectin substances to obtain elementary fibers of very low linear density, which brings the properties of cottonized linen fiber closer to cotton fiber.

PHYSICAL-MECHANICAL SPECIFICATION OF COTTONIZED LINEN FIBER

Type of fiber	Composition	Linear density, not more than, tex	Mass fraction of sheaves and trash, not more than, %	Mass fraction of fibers of length up to 15 mm, not more than, %	Mass fraction of fibers of length over 40 mm, not more than, %	Average fiber length, mm	Weight of one bale, kg
Bleached Co	100 % flax	1,50	1,0	20,0	65,0	35,0	350
Boiled Co	100 % flax	1,50	1,0	20,0	65,0	35,0	350
Natural Co	100 % flax	1,95	2,5	15,0	75,5	40,0	200



Fiber is packed in bales, each bale is tied with metallic sliver and marked with an information sticker. The shipment is carried out at export prices on FCA Orsha terms. Customs code of cottonized linen fiber is 5301290000.





ORSHA LINEN MILL



3 Molodezhnaya street, Orsha,
211382, Belarus



+375 (29) 281 33 33



+375 (216) 53 21 38
+375 (216) 53 16 51



info@linenmill.by

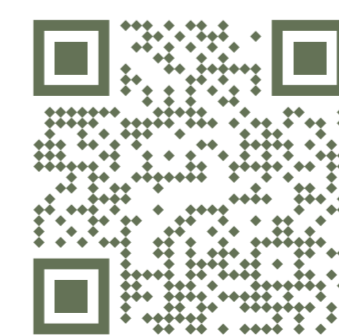

www.linenmill.by

POLE ǨVETAK
by Orsha Linen Mill

JSC «RUCHAIKA»

PVC TENT MATERIAL



JSC «RUCHAIKA» TODAY

- PRODUCES **TENT MATERIALS**, ROOFING MEMBRANE, MATERIALS FOR MINE VENTILATION, TECHNICAL AND DECORATIVE FABRICS, GEOTEXTILES, FINISHED PVC TENT PRODUCTS.
- MORE THAN 60% OF THE COMPANY'S PRODUCTS ARE EXPORTED TO THE CIS COUNTRIES, NEAR AND FAR ABROAD

ABOUT US

ruchaika.by

ABOUT US

- THE ONLY IN THE REPUBLIC OF BELARUS AND ONE OF THE LARGEST IN THE CIS MANUFACTURER OF TENT MATERIALS, MATERIALS FOR MINE VENTILATION, ROOFING MEMBRANE AND WATERPROOFING MATERIALS.
- ONE OF THE LARGEST CIS MANUFACTURERS OF TECHNICAL AND DECORATIVE FABRICS, TENT BACKING FABRICS.

ABOUT US

TENT MATERIAL



TENT MATERIAL

PRODUCT RANGE

TENT MATERIAL

- THE PRODUCTION CYCLE OF TENT MATERIAL CONSISTS OF THE FOLLOWING STAGES: WEAVING OF BASES, APPLICATION OF PVC COMPOSITION. TENT MATERIAL CAN BE PRODUCED IN VARIOUS DENSITIES: FROM 450 TO 1300 G/M² WITH DIFFERENT CHARACTERISTICS.
- PRODUCTION OF PVC MATERIALS IS CARRIED OUT ON MODERN EQUIPMENT OF ISOTEX (ITALY).

TENT MATERIAL

- 1 - reinforcing fabric**
- 2 - base coat**
- 3 - PVC coating**
- 4 - varnish**

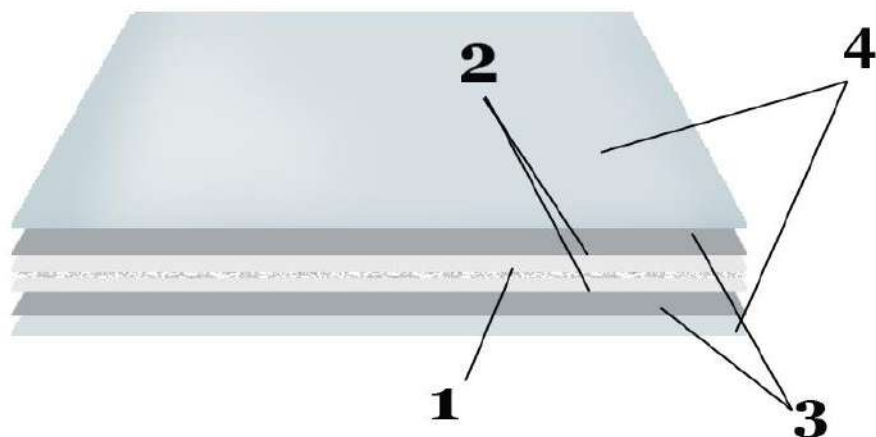

TENT MATERIAL

PRODUCT RANGE

TENT MATERIAL

- TENT MATERIAL "RUCHAIKA" IS A THREE-LAYER PVC MATERIAL. THE BASIS OF THE MATERIAL IS A FABRIC MADE OF POLYESTER TECHNICAL THREADS. THE BASE IS COATED ON BOTH SIDES WITH A PVC COMPOSITION, ADDITIONALLY IT CAN BE VARNISHED ON ONE OR TWO SIDES.
- PVC RESIN GIVES THE MATERIAL DURABILITY. THE MATERIAL HAS EXCELLENT LIGHT FASTNESS.



TENT MATERIAL



ruchaika.by

APPLICATION OF PVC TENT MATERIALS

- PRODUCTION OF ARCHITECTURAL AND FRAME STRUCTURES, FRAME TENT STRUCTURES, LARGE HANGARS, LARGE SHEDS, OUTDOOR CAFES, PAVILIONS, TEMPORARY STORAGE WAREHOUSES;
- PRODUCTION OF CAR COVERS, HANGARS, INFLATABLE BOATS, INFLATABLE TRAMPOLINES, ATTRACTIONS, TUBING (CHEESECAKES);
- FOR CANOPIES, CURTAINS, SHELTERS AND OTHER TECHNICAL PURPOSES.

TENT MATERIAL

PRODUCT RANGE

TENT MATERIAL

THE RANGE OF TENT MATERIALS



TENT MATERIAL

TENT MATERIAL

PRODUCT RANGE

TENT MATERIAL

- FOR CURTAINS, BLINDS WITHOUT LACQUER
- FOR CAR COVERS, WITH ONE-SIDED LACQUER
- FOR ARCHITECTURAL AND FRAME STRUCTURES WITH 2-SIDED LACQUER
- FOR ARCHITECTURAL AND FRAME STRUCTURES WITH 2-SIDED LACQUER. FROST-RESISTANT (UP TO 50 °C)
- FOR ARCHITECTURAL AND FRAME STRUCTURES WITH 2-SIDED LACQUER. FIRE-RESISTANT (G1-G2)



TENT MATERIAL



FOR CURTAINS, BLINDS WITHOUT LACQUER

TENT MATERIAL

PRODUCT RANGE

- IT IS DESIGNED FOR THE MANUFACTURE OF CURTAINS, BLINDS, SHELTERS AND OTHER TECHNICAL PURPOSES. IT HAS A LIGHT WEIGHT MASS.

ADVANTAGES:

- - MATERIAL OPTIMALLY COMBINES LIGHTNESS, STRENGTH AND ELASTICITY;
- - WATERPROOF;
- - NON-TOXIC;
- - RESISTANT TO PETROL AND OILS
- - RESISTANT TO TEMPERATURE CHANGES FROM - 30°C UP TO +70°C.

TENT MATERIAL

TECHNICAL SPECIFICATIONS



MATERIAL FOR CURTAINS, BLINDS

TENT MATERIAL

PRODUCT RANGE

TENT MATERIAL

	Index	Value			
1	Weight of 1m ² , g	500	550	600	630
2	Breaking load (20x100) mm, N	950	1000	1050	1200
	- warp	750	800	850	850-950
3	Resistance to tearing, N	200	250	270	280
	- warp	200	250	260	270
4	Elongation at break, %	15-40			
	- warp	20-40			
5	Temperature resistance, the lower limit, C	-30			
6	Temperature resistance, the upper limit, C	+70			
7	Fire resistance, mm / min	100			
8	Adhesion, N / 50m	80	100	80-100	80-100
9	Roll length, m, ±2,5 cm	50-65			
10	Roll width, m, ±2,5 cm	2,5-3,2			

TENT MATERIAL



**FABRICS FOR CAR COVERS
(ONE-SIDED VARNISHING)**

TENT MATERIAL

PRODUCT RANGE

TENT MATERIAL

- IT IS DESIGNED FOR THE MANUFACTURE OF CAR COVERS, FRAME TENT STRUCTURES, HANGARS, INFLATABLE TRAMPOLINE, RIDES, TUBING (CHEESECAKES) AND OTHER TECHNICAL PURPOSES.

THE ADVANTAGES:

- - MATERIAL OPTIMALLY COMBINES LIGHTNESS, STRENGTH AND ELASTICITY;
- - WATERPROOF;
- - NON-TOXIC;
- RESISTANT TO PETROL AND OILS;
- - RESISTANT TO TEMPERATURE CHANGES FROM -30°C UP TO $+70^{\circ}\text{C}$;
- - FROST RESISTANCE TO -60°C ;
- - ABILITY TO PRINT WITH SOLVENT INK ON THE TENT;
- - ROLL WIDTH 3,2 M;
- - IT IS POSSIBLE TO PRODUCE MATERIALS MEETING ALL PHYSICAL AND MECHANICAL PROPERTIES APPLIED BY THE CUSTOMER
- - RICH COLORS.

TECHNICAL SPECIFICATIONS



FABRICS FOR CAR COVERS

TENT MATERIAL

PRODUCT RANGE

TENT MATERIAL

	Index	Value				
1	Weight of 1m2, g	600	630	650	750	900
2	Breaking load (20x100) mm, N	1050	1100-1200	1100-1200	1200	1500
	- warp	850	850-950	900-1000	1100	1200
3	Resistance to tearing, N	270	280	290	270	500
	- warp	260	270	290	260	400
4	Elongation at break, %	15-40				
	- warp	20-40				
5	Temperature resistance, the lower limit, C	-30				
6	Temperature resistance, the upper limit, C	+70				
7	Fire resistance, mm / min	100				
8	Adhesion, N / 50m	80-100	80-100	90-100	80-100	100
9	Roll length, m, ±2,5 cm	65	50-65	50-65	50-65	50
10	Roll width, m, ±2,5 cm	2,5	2,5-3,2	2,5-3,2	2,5-3,0	3,0

TENT MATERIAL



**MATERIAL FOR ARCHITECTURAL AND
FRAME STRUCTURES**

TENT MATERIAL

ruchaika.by

PRODUCT RANGE

- IT IS DESIGNED FOR THE MANUFACTURE OF ARCHITECTURAL AND FRAME STRUCTURES, FRAME TENT STRUCTURES, LARGE SHEDS, OUTDOOR CAFES, PAVILIONS, TEMPORARY STORAGE WAREHOUSES, AND OTHER INDUSTRIAL PURPOSES.

ADVANTAGES:

- - MATERIAL OPTIMALLY COMBINES LIGHTNESS, STRENGTH AND ELASTICITY;
- - WATERPROOF;
- - NON-TOXIC;
- - RESISTANT TO PETROL AND OILS;
- - TEFLON COATING WITH PVDV VARNISH INCREASES RESISTANCE TO UV RADIATION AND INCREASES THE SERVICE LIFE;
- - RESISTANT TO TEMPERATURE CHANGES FROM -30°C UP TO $+70^{\circ}\text{C}$;
- - FROST RESISTANCE TO -60°C ;
- - RESISTANCE TO COMBUSTION BY "FIRE-SAFE" - G1 AND G2;
- - ABILITY TO PRINT WITH SOLVENT INKS.

TENT MATERIAL

TECHNICAL SPECIFICATIONS



**MATERIAL FOR ARCHITECTURAL AND
FRAME STRUCTURES**

TENT MATERIAL

PRODUCT RANGE

TENT MATERIAL

	Index	Value			
1	Weight of 1m2, g	630	650	750	900
2	Breaking load (20x100) mm, N - warp - weft	1100-1200 850-950	1100-1200 900-1000	1200 1100	1500 1200
3	Resistance to tearing, N - warp - weft	280 270	290 290	270 260	500 400
4	Elongation at break, % - warp - weft	15-40 20-40			
5	Temperature resistance, the lower limit, C	-30			
6	Temperature resistance, the upper limit, C	+70			
7	Fire resistance, mm / min	100			
8	Adhesion, N / 50m	90	90	90	100
9	Roll length, m, ±2,5 cm	50-65		50	
10	Roll width, m, ±2,5 cm	2,5-3,2		3,0	



WELDING RECOMMENDATIONS



TENT MATERIAL

TENT MATERIAL

PRODUCT RANGE

TENT MATERIAL

	Density	Machine	Welding speed	Welding temperature
1	MT, МТМП-450	LEISTER UNIPLAN E	4,7-5 m/min	620 C°
2	MT, MT1, MT2-500	LEISTER UNIPLAN E	4,7-5 m/min	620 C°
3	MT-550	LEISTER UNIPLAN E	4,7 m/min	620 C°
4	MTM, МТП-550	LEISTER VARIMAT	4,0 m/min	620 C°
5	MT, MT1-600	LEISTER UNIPLAN E	4,5-5 m/min	620 C°
6	MT, MT1, MT2 – 630-650	LEISTER UNIPLAN E	4,5-5 m/min	620 C°
7	MTM, MTM1, МТП, МТП1, МТМП- 630-650	LEISTER VARIMAT	4,5-4,7 m/min	620 C°
8	MTA-630	LEISTER UNIPLAN E	6-7 m/min	620 C°
9	MT1, MT2, МТП1, МТМ1, МТМП1- 750	LEISTER UNIPLAN E	on request for testing	620 C°
10	MT1, MT2, MTM, MTM1, МТП1, МТМП1, МТП2, МТМП2-900	LEISTER VARIANT T1	4,2-4,5 m/min	620 C°
11	MT2-1100	LEISTER VARIMAT	on request for testing	620 C°
12	MT, MT2-1300	LEISTER VARIMAT	on request for testing	620 C°
13	МТП2-1350	LEISTER VARIMAT	on request for testing	620 C°

TENT MATERIAL «RUCHAIKA»



TENT MATERIAL

PRODUCT RANGE

TENT MATERIAL

ADVANTAGES

- OPTIMALLY COMBINES THE RELIABILITY, STRENGTH AND ELASTICITY;
- NON-TOXIC, NO ADVERSE EFFECTS ON THE HUMAN BODY;
- POSSIBILITY TO MANUFACTURE MATERIALS IN ACCORDANCE WITH ALL PHYSICAL AND MECHANICAL PROPERTIES APPLIED BY THE CUSTOMER;
- RESISTANT TO PETROL AND OILS;
- ABILITY TO PRINT WITH SOLVENT INK ON THE TENT;
- WIDE RANGE OF COLORS ACCORDING TO THE CATALOG RAL COLORS OR AS AGREED WITH THE CUSTOMER;
- WIDTH OF ROLLS CAN BE FROM 2,5 M TO 3,2 M.



ruchaika.by

CERTIFICATES



ABOUT THE COMPANY

TENT MATERIAL

ABOUT THE COMPANY

- THE HIGH LEVEL OF ORGANIZATION OF MATERIAL'S PRODUCTION, CONFIRMED BY A CERTIFICATE OF CONFORMITY OF QUALITY MANAGEMENT SYSTEM STB ISO 9001-2009. YEARS OF EXPERIENCE, QUALIFIED PERSONNEL, EFFICIENT USE OF PROCESSING EQUIPMENT, COOPERATION WITH DOMESTIC AND FOREIGN BUSINESS PARTNERS, ALLOW THE COMPANY TO PRODUCE A WIDE RANGE OF HIGH QUALITY TEXTILE AND TECHNICAL MATERIALS.
- IN 2013, 2015, 2018, 2021 AS A RESULT OF THE CONCLUSION OF THE EXPERT COUNCIL TENT AND ROOFING MATERIAL MANUFACTURED BY JSC "RUCHAIKA" WON THE CONTEST IN THE NOMINATION "THE BEST BUILDING MATERIAL (PRODUCT) OF THE YEAR".



JSC «RUCHAİKA»



TENT MATERIAL

CONTACT DETAIL

ruchaika.by

CONTACT DETAILS

CONTACT US TO DISCUSS TERMS



www.ruchaika.by



139-7 Sovetskaya str.
Brest region, Kobrin
225304, Republic of Belarus



+375 1642 3 44 06
+375 33 637 18 36
+375 29 692 24 73



market@ruchaika.by

CONTACT DETAILS

JSC «RUCHAIKA»

QUALITY TRADITIONS. MODERN TECHNOLOGY.



The art of creating fabrics



THE HISTORY OF THE COMPANY

Kamvol is one of the largest manufacturers of high-quality exclusive wool fabrics in the CIS and Europe.

Since 1955, our company has been constantly developing.

MAIN PRODUCTION:
Belarus, Minsk, Mayakovsky 176

NOWADAYS JSC KAMVOL IS..



> **112,000** sq meters of production space;



> **300** fabric articles;



> **2,000** color nozzles in the industrial collection;



the ability to produce more than **6 million** linear meters per year;



a wide range of products.





FABRICS FOR DEPARTMENTAL INSTITUTIONS

АРТИКУЛ/ARTICLE 03С46

РИСУНОК/COLOUR 11-2

назначение/purpose: форма
следственного комитета/ uniform of
the Investigative Committee

СОСТАВ/COMPOSITION

Шерсть/Wool — **45%**, ПЭ/PES — **55%**

Ширина/Width — **152 см/cm**

Вес/Weight — **257 гм2/gm2**



АРТИКУЛ/ARTICLE 03С46

РИСУНОК/COLOUR 773-11

назначение/purpose: форма
следственного комитета/ uniform of
the Investigative Committee

СОСТАВ/COMPOSITION

Шерсть/Wool — **45%**, ПЭ/PES — **55%**

Ширина/Width — **152 см/cm**

Вес/Weight — **257 гм2/gm2**



АРТИКУЛ/ARTICLE 05С54

РИСУНОК/COLOUR 473-1

назначение/purpose: форма МВД,
МЧС РБ/ uniform of the MIA, MES

СОСТАВ/COMPOSITION

Шерсть/Wool — **45%**, ПЭ/PES — **55%**

Ширина/Width — **152 см/cm**

Вес/Weight — **288 гм2/gm2**



АРТИКУЛ/ARTICLE 05С54

РИСУНОК/COLOUR 4-1

назначение/purpose: форма МВД,
МЧС РФ/ uniform of the MIA, MES

СОСТАВ/COMPOSITION

Шерсть/Wool — **45%**, ПЭ/PES — **55%**

Ширина/Width — **152 см/cm**

Вес/Weight — **288 гм2/gm2**



АРТИКУЛ/ARTICLE 05С55

РИСУНОК/COLOUR 4-2

назначение/purpose: форма
следственного комитета/ uniform of
the Investigative Committee

СОСТАВ/COMPOSITION

Шерсть/Wool — **66%**, ПЭ/PES — **34%**

Ширина/Width — **152 см/см**

Вес/Weight — **300 гм2/гм2**



АРТИКУЛ/ARTICLE 05С55

РИСУНОК/COLOUR 3-2

назначение/purpose: форма
следственного комитета/ uniform of
the Investigative Committee

СОСТАВ/COMPOSITION

Шерсть/Wool — **66%**, ПЭ/PES — **34%**

Ширина/Width — **152 см/cm**

Вес/Weight — **300 гм2/gm2**



АРТИКУЛ/ARTICLE 05С55

РИСУНОК/COLOUR 7-2

назначение/purpose: форма
следственного комитета/ uniform of
the Investigative Committee

СОСТАВ/COMPOSITION

Шерсть/Wool — **66%**, ПЭ/PES — **34%**

Ширина/Width — **152 см/см**

Вес/Weight — **300 гм2/гм2**



АРТИКУЛ/ARTICLE 07С42

РИСУНОК/COLOUR 8-2

назначение/purpose: форма
охраны, кадетов, курсантов/
uniform of the security, cadets

СОСТАВ/COMPOSITION

Шерсть/Wool — **66%**, ПЭ/PES — **34%**

Ширина/Width — **152 см/cm**

Вес/Weight — **300 гм2/gm2**



АРТИКУЛ/ARTICLE 07С42

РИСУНОК/COLOUR 749-1

назначение/purpose: форма
охраны, кадетов, курсантов/
uniform of the security, cadets

СОСТАВ/COMPOSITION

Шерсть/Wool — **33%**, ПЭ/PES — **67%**

Ширина/Width — **152 см/cm**

Вес/Weight — **285 гм2/gm2**



АРТИКУЛ/ARTICLE 07С42

РИСУНОК/COLOUR 762-1

назначение/purpose: форма
охраны, кадетов, курсантов/
uniform of the security, cadets

СОСТАВ/COMPOSITION

Шерсть/Wool — **33%**, ПЭ/PES — **67%**

Ширина/Width — **152 см/cm**

Вес/Weight — **285 гм2/gm2**



АРТИКУЛ/ARTICLE 07С63

РИСУНОК/COLOUR 620-1

назначение/purpose: форма
таможенных органов/ uniform of the
customs authorities

СОСТАВ/COMPOSITION

Шерсть/Wool — **45%**, ПЭ/PES — **55%**

Ширина/Width — **152 см/cm**

Вес/Weight — **270 гм2/gm2**



АРТИКУЛ/ARTICLE 07С70

РИСУНОК/COLOUR 5-1

назначение/purpose: форма РЖД/
uniform of the RZD

СОСТАВ/COMPOSITION

Шерсть/Wool — **43%**, ПЭ/PES — **55%**,

Лайкра/Lycra — **2%**

Ширина/Width — **152 см/см**

Вес/Weight — **210 гм2/гм2**



АРТИКУЛ/ARTICLE 07С70

РИСУНОК/COLOUR 31-5

назначение/purpose: форма РЖД/
uniform of the RZD

СОСТАВ/COMPOSITION

Шерсть/Wool — **43%**, ПЭ/PES — **55%**,

Лайкра/Lycra — **2%**

Ширина/Width — **152 см/cm**

Вес/Weight — **210 гм2/gm2**



АРТИКУЛ/ARTICLE 09С45

РИСУНОК/COLOUR 3-2

назначение/purpose: форма БЖД,
следственный комитет РФ/ uniform
of the BZD, Investigative Committee

СОСТАВ/COMPOSITION

Шерсть/Wool — **44%**, ПЭ/PES — **54%**,

Лайкра/Lycra — **2%**

Ширина/Width — **152 см/см**

Вес/Weight — **250 гм2/гм2**



АРТИКУЛ/ARTICLE 09С45

РИСУНОК/COLOUR 6-2

назначение/purpose: форма
кадетов РБ/ uniform of the cadets

СОСТАВ/COMPOSITION

Шерсть/Wool — **44%**, ПЭ/PES — **54%**,

Лайкра/Lycra — **2%**

Ширина/Width — **152 см/cm**

Вес/Weight — **250 гм2/gm2**



АРТИКУЛ/ARTICLE 09С45

РИСУНОК/COLOUR 7-2

назначение/purpose: форма
таможенной службы РФ/ uniform of
the customs authorities

СОСТАВ/COMPOSITION

Шерсть/Wool — **44%**, ПЭ/PES — **54%**,

Лайкра/Lycra — **2%**

Ширина/Width — **152 см/cm**

Вес/Weight — **250 гм2/gm2**



АРТИКУЛ/ARTICLE 10С26

РИСУНОК/COLOUR 15-2

СОСТАВ/COMPOSITION

Шерсть/Wool — **45%**, ПЭ/PES — **55%**,

Ширина/Width — **238 см/cm**

Вес/Weight — **238 гм2/gm2**



АРТИКУЛ/ARTICLE 10С26

РИСУНОК/COLOUR 8-2

СОСТАВ/COMPOSITION

Шерсть/Wool — **45%**, ПЭ/PES — **55%**,

Ширина/Width — **154 см/cm**

Вес/Weight — **238 гм2/gm2**



АРТИКУЛ/ARTICLE 13С27

РИСУНОК/COLOUR 1-2

назначение/purpose: форма
министерства обороны РФ/
uniform of the Ministry of Defence

СОСТАВ/COMPOSITION

Шерсть/Wool — 65%, ПЭ/PES — 35%,
Ширина/Width — 152 см/cm
Вес/Weight — 280 гм2/gm2



АРТИКУЛ/ARTICLE 13С27

РИСУНОК/COLOUR 476-1

назначение/purpose: форма
министерства обороны/ uniform of
the Ministry of Defence

СОСТАВ/COMPOSITION

Шерсть/Wool — **65%**, ПЭ/PES — **35%**,
Ширина/Width — **152 см/cm**
Вес/Weight — **280 гм2/gm2**



АРТИКУЛ/ARTICLE 13С27

РИСУНОК/COLOUR 872-1

назначение/purpose: форма
министерства обороны РФ/
uniform of the Ministry of Defence

СОСТАВ/COMPOSITION

Шерсть/Wool — **65%**, ПЭ/PES — **35%**,
Ширина/Width — **152 см/cm**
Вес/Weight — **280 гм2/gm2**



АРТИКУЛ/ARTICLE 14С42

РИСУНОК/COLOUR 760-1

назначение/purpose: форма РЖД/
uniform of the RZD

СОСТАВ/COMPOSITION

Шерсть/Wool — **30%**, ПА/РА — **70%**,

Ширина/Width — **152 см/cm**

Вес/Weight — **240 гм2/gm2**



АРТИКУЛ/ARTICLE 20С82

РИСУНОК/COLOUR 5-3

назначение/purpose: форма РЖД,
метрополитен/ uniform of the RZD
metro

СОСТАВ/COMPOSITION

Шерсть/Wool — **44%**, ПЭ/PES — **54%**,

Лайкра/Lycra — **2%**

Ширина/Width — **152 см/см**

Вес/Weight — **223 гм2/гм2**



АРТИКУЛ/ARTICLE 20С82

РИСУНОК/COLOUR 6-3

назначение/purpose: форма РЖД,
метрополитен/ uniform of the RZD
metro

СОСТАВ/COMPOSITION

Шерсть/Wool — **44%**, ПЭ/PES — **54%**,

Лайкра/Lycra — **2%**

Ширина/Width — **152 см/cm**

Вес/Weight — **223 гм2/gm2**

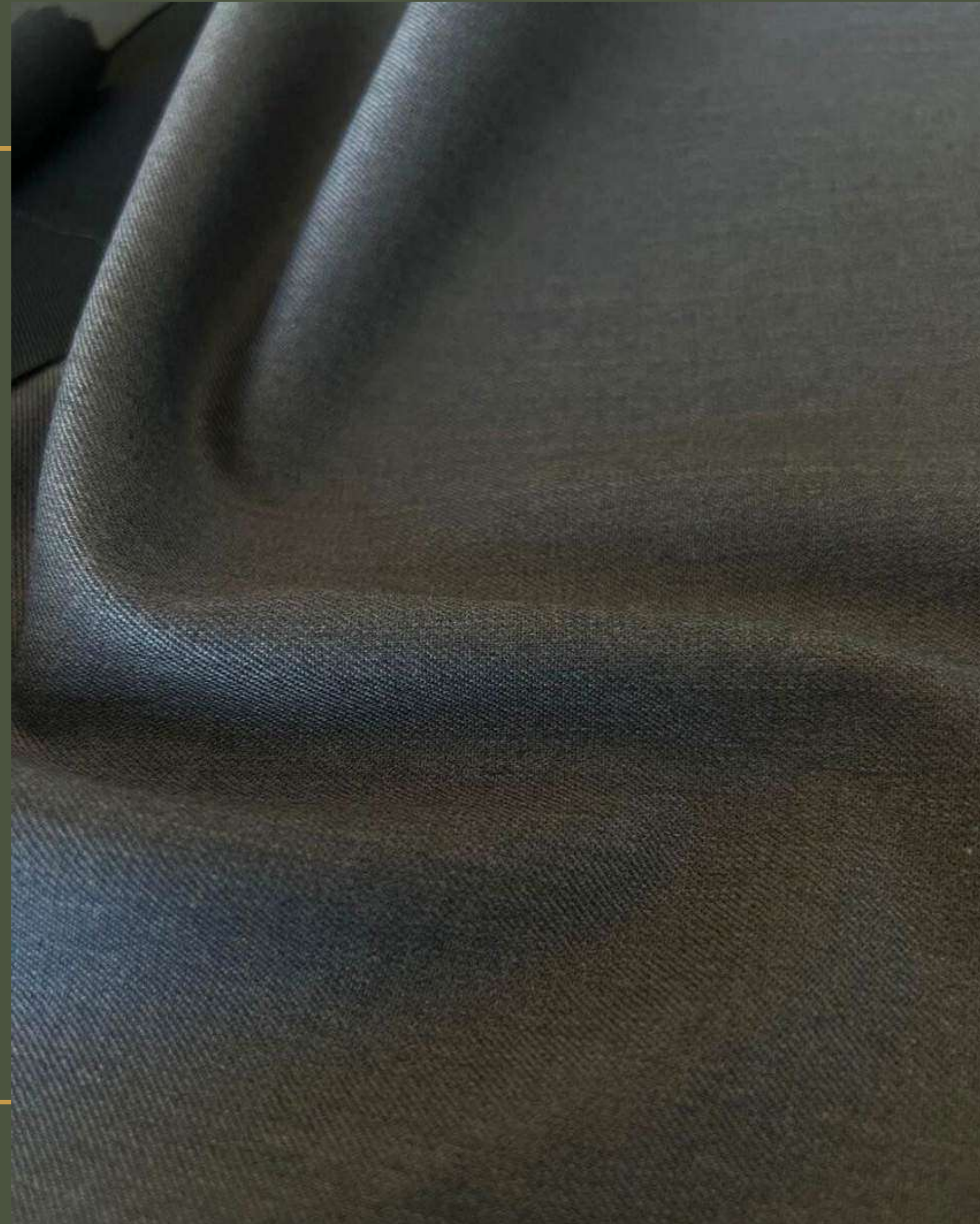

АРТИКУЛ/ARTICLE 20С82

РИСУНОК/COLOUR 6-3

назначение/purpose: форма РЖД,
метрополитен/ uniform of the RZD
metro

СОСТАВ/COMPOSITION

Шерсть/Wool — **44%**, ПЭ/PES — **54%**,

Лайкра/Lycra — **2%**

Ширина/Width — **152 см/cm**

Вес/Weight — **223 гм2/gm2**



АРТИКУЛ/ARTICLE 20С82

РИСУНОК/COLOUR 10-3

назначение/purpose: форма РЖД,
метрополитен/ uniform of the RZD
metro

СОСТАВ/COMPOSITION

Шерсть/Wool — **44%**, ПЭ/PES — **54%**,

Лайкра/Lycra — **2%**

Ширина/Width — **152 см/cm**

Вес/Weight — **223 гм2/gm2**



АРТИКУЛ/ARTICLE 23С89

РИСУНОК/COLOUR 1-3

назначение/purpose: форма
охраны, кадетов, курсантов/
uniform of the security, cadets

СОСТАВ/COMPOSITION

Шерсть/Wool — **40%**, ПЭ/PES — **60%**,
Ширина/Width — **152 см/cm**
Вес/Weight — **290 гм2/gm2**





WOOLEN CLOTH FOR DEPARTMENTAL INSTITUTIONS

АРТИКУЛ/ARTICLE 23СП81

РИСУНОК/COLOUR 1-3

назначение/purpose: форма для моряков РФ/ mariner's uniform

СОСТАВ/COMPOSITION

Шерсть/Wool — **64%**, ПА/РА — **36%**

Ширина/Width — **142 см/cm**

Вес/Weight — **481 гм2/gm2**



АРТИКУЛ/ARTICLE 24СП72

РИСУНОК/COLOUR 2-3

назначение/purpose: верхняя
одежда/ outerwear

СОСТАВ/COMPOSITION

Шерсть/Wool — **90%**, ПА/РА — **10%**

Ширина/Width — **155 см/см**

Вес/Weight — **760 гм2/гм2**



АРТИКУЛ/ARTICLE 24СП72

РИСУНОК/COLOUR 1-3

назначение/purpose: верхняя
одежда/ outerwear

СОСТАВ/COMPOSITION

Шерсть/Wool — **90%**, ПА/РА — **10%**

Ширина/Width — **155 см/cm**

Вес/Weight — **760 гм2/gm2**



АРТИКУЛ/ARTICLE 24СП72

РИСУНОК/COLOUR 3-3

назначение/purpose: верхняя
одежда/ outerwear

СОСТАВ/COMPOSITION

Шерсть/Wool — **90%**, ПА/РА — **10%**

Ширина/Width — **155 см/см**

Вес/Weight — **760 гм2/гм2**



АРТИКУЛ/ARTICLE 24СП72

РИСУНОК/COLOUR 4-3

назначение/purpose: верхняя
одежда/ outerwear

СОСТАВ/COMPOSITION

Шерсть/Wool — **90%**, ПА/РА — **10%**

Ширина/Width — **155 см/cm**

Вес/Weight — **760 гм2/gm2**



АРТИКУЛ/ARTICLE 24СП72

РИСУНОК/COLOUR 5-3

назначение/purpose: верхняя одежда,
тех.ткань для хлебозаводов РФ/outerwear,
technical fabric for bread factory

СОСТАВ/COMPOSITION

Шерсть/Wool — **90%**, ПА/РА — **10%**

Ширина/Width — **155 см/cm**

Вес/Weight — **760 гм2/gm2**

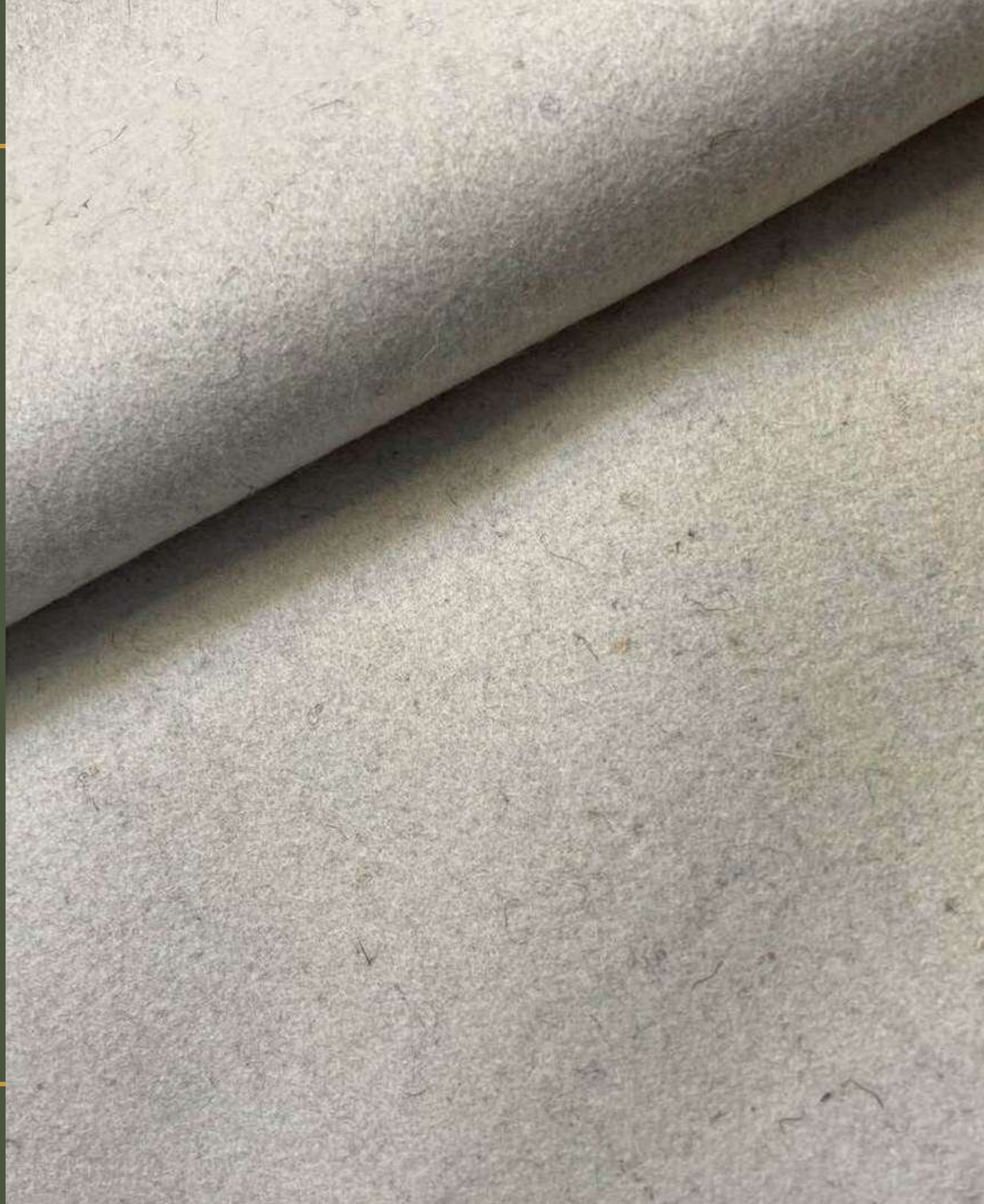

АРТИКУЛ/ARTICLE 24СП74

РИСУНОК/COLOUR 1-3

назначение/purpose: верхняя
одежда/ outerwear

СОСТАВ/COMPOSITION

Шерсть/Wool — **90%**, ПА/РА — **10%**

Ширина/Width — **142 см/cm**

Вес/Weight — **634 гм2/gm2**



АРТИКУЛ/ARTICLE 24СП74

РИСУНОК/COLOUR 3-3

назначение/purpose: форма
внутренних войск/ the uniform of
the internal troops

СОСТАВ/COMPOSITION

Шерсть/Wool — **90%**, ПА/РА — **10%**

Ширина/Width — **142 см/cm**

Вес/Weight — **634 гм2/gm2**



АРТИКУЛ/ARTICLE 24СП74

РИСУНОК/COLOUR 6-3

назначение/purpose: форма
внутренних войск/ the uniform of
the internal troops

СОСТАВ/COMPOSITION

Шерсть/Wool — **90%**, ПА/РА — **10%**

Ширина/Width — **142 см/cm**

Вес/Weight — **634 гм2/gm2**



АРТИКУЛ/ARTICLE СП-44-24

РИСУНОК/COLOUR 1-3

назначение/purpose: верхняя
одежда/ outerwear

СОСТАВ/COMPOSITION

Шерсть/Wool — **90%**, ПА/РА — **10%**

Ширина/Width — **152 см/cm**

Вес/Weight — **760 гм2/gm2**



АРТИКУЛ/ARTICLE СП-44-24

РИСУНОК/COLOUR 2-3

назначение/purpose: верхняя
одежда/ outerwear

СОСТАВ/COMPOSITION

Шерсть/Wool — **90%**, ПА/РА — **10%**

Ширина/Width — **152 см/см**

Вес/Weight — **760 гм2/гм2**



АРТИКУЛ/ARTICLE 23СП72

РИСУНОК/COLOUR 1-3

назначение/purpose: верхняя одежда,
подкладка головных уборов РФ/ outerwear,
lining of hats

СОСТАВ/COMPOSITION

Шерсть/Wool — **78%**, ПА/РА — **22%**

Ширина/Width — **152 см/cm**

Вес/Weight — **452 гм2/gm2**

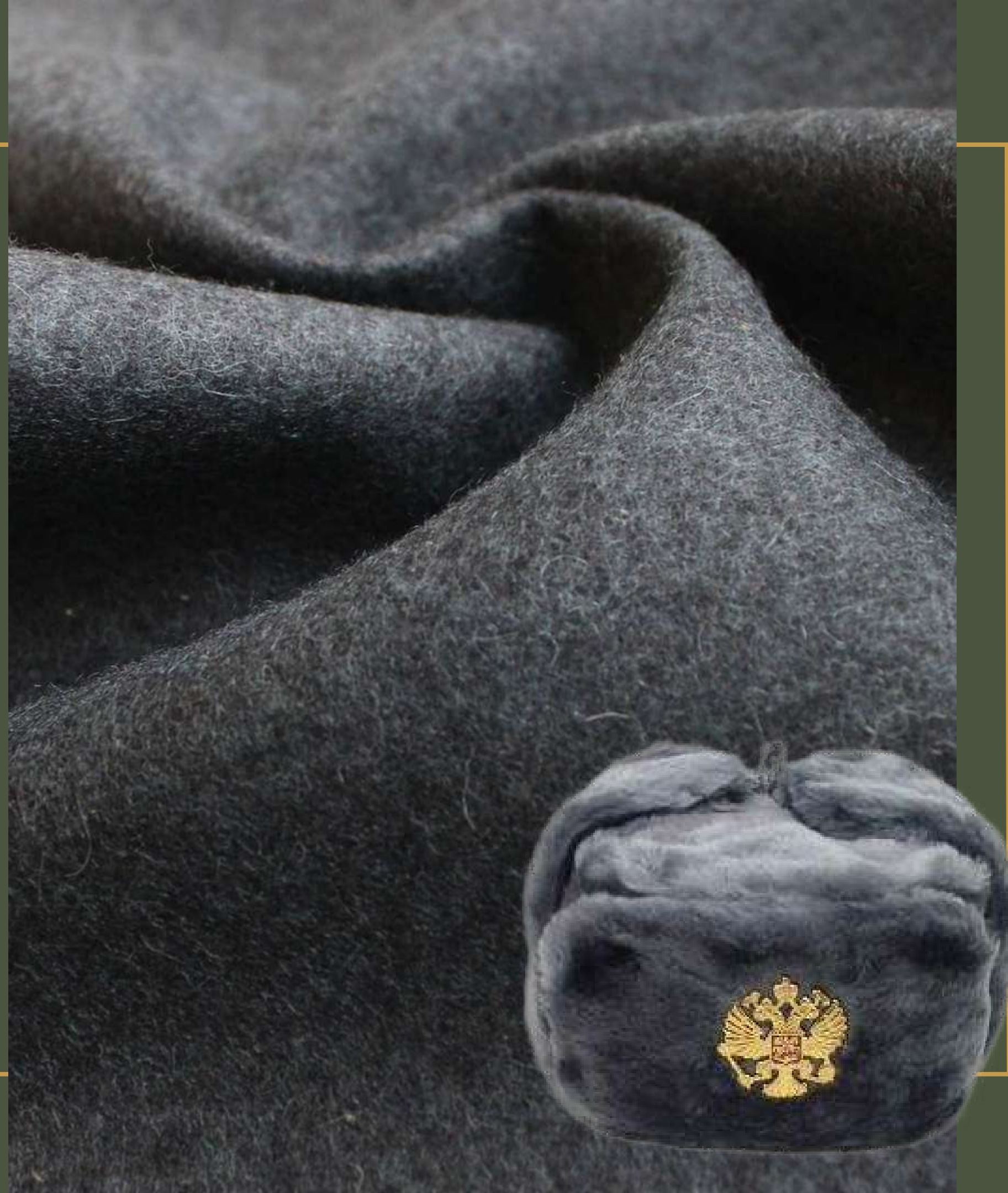

АРТИКУЛ/ARTICLE 23СП72

РИСУНОК/COLOUR 2-3

назначение/purpose: верхняя одежда,
подкладка головных уборов РФ/ outerwear,
lining of hats

СОСТАВ/COMPOSITION

Шерсть/Wool — **78%**, ПА/РА — **22%**

Ширина/Width — **152 см/cm**

Вес/Weight — **452 гм2/gm2**



АРТИКУЛ/ARTICLE 23СП72

РИСУНОК/COLOUR 3-3

назначение/purpose: верхняя одежда,
подкладка головных уборов РФ/ outerwear,
lining of hats

СОСТАВ/COMPOSITION

Шерсть/Wool — **78%**, ПА/РА — **22%**

Ширина/Width — **152 см/cm**

Вес/Weight — **452 гм2/gm2**



АРТИКУЛ/ARTICLE 23СП72

РИСУНОК/COLOUR 4-3

назначение/purpose: верхняя одежда,
подкладка головных уборов РФ/ outerwear,
lining of hats

СОСТАВ/COMPOSITION

Шерсть/Wool — **78%**, ПА/РА — **22%**

Ширина/Width — **152 см/cm**

Вес/Weight — **452 гм2/gm2**



АРТИКУЛ/ARTICLE 23СП72

РИСУНОК/COLOUR 6-3

назначение/purpose: верхняя одежда,
подкладка головных уборов РФ/ outerwear,
lining of hats

СОСТАВ/COMPOSITION

Шерсть/Wool — **78%**, ПА/РА — **22%**

Ширина/Width — **152 см/cm**

Вес/Weight — **452 гм2/gm2**





JOIN OUR PARTNERSHIP

JSC «KAMVOL» ADDRESS:

176, Mayakovskogo str., 220028, Minsk, Republic of Belarus.

CONTACTS:

 **SALES:** land +375 17 377 20 08
+375 17 374 14 00

 sales@kamvol.by

 [kamvol](https://www.instagram.com/kamvol)

 [@kamvol1955](https://www.telegram.com/@kamvol1955)



www.kamvol.by

MOGOTEX

«

2720

Number of staff

37 M²
million

Annual
production

2,6 M²
million

Processed into
finished products

45 years

On the market

57 \$
million

Annual
turnover

3

Production
sites

«

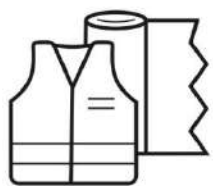

Wide range
of products



Own production
capacity



Stock availability

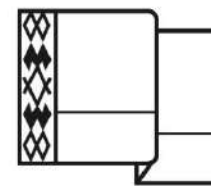

Production in the
Republic of Belarus



Quality
management
system



Favourable
terms



Customized
approach



WEAVING FACTORY

3 productive capacity
million lin.m.
grey fabrics per
month





FINISHING FACTORY

4

productive capacity
million lin.m. per month
(dyeing and finishing)





SEWING FACTORY

215

productive capacity
thousand square meters
meters of fabric processed
into finished products

95

thousand ready products
per month





■ 13,2%

finished products

■ 3,8%

technical textile

■ 9,5%

fabrics for interior decoration

■ 73,4%

fabrics for clothing



TEXTILE THAT WORKS

(M)

For military uniforms



For employees of
the Ministry
of Emergencies



For the oil and
gas companies



MOGOTEX

ADVANCED MULTIFUNCTIONAL LIGHT FABRICS



TEXTILE THAT WORKS

(M)

For firefighters



For protection against thermal risks of an electric arc



MEMBRANE LAMINATED FABRICS

Doubled:

- with knitted fabric
- with fleece

FABRIC + MEMBRANE + KNITTED FABRIC

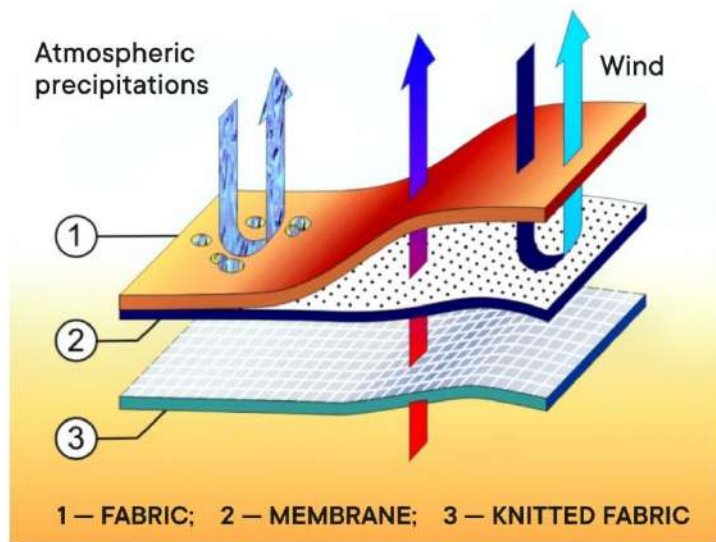

NO PERMEABILITY FOR:

Moisture vapor



Rain



Wind



Show

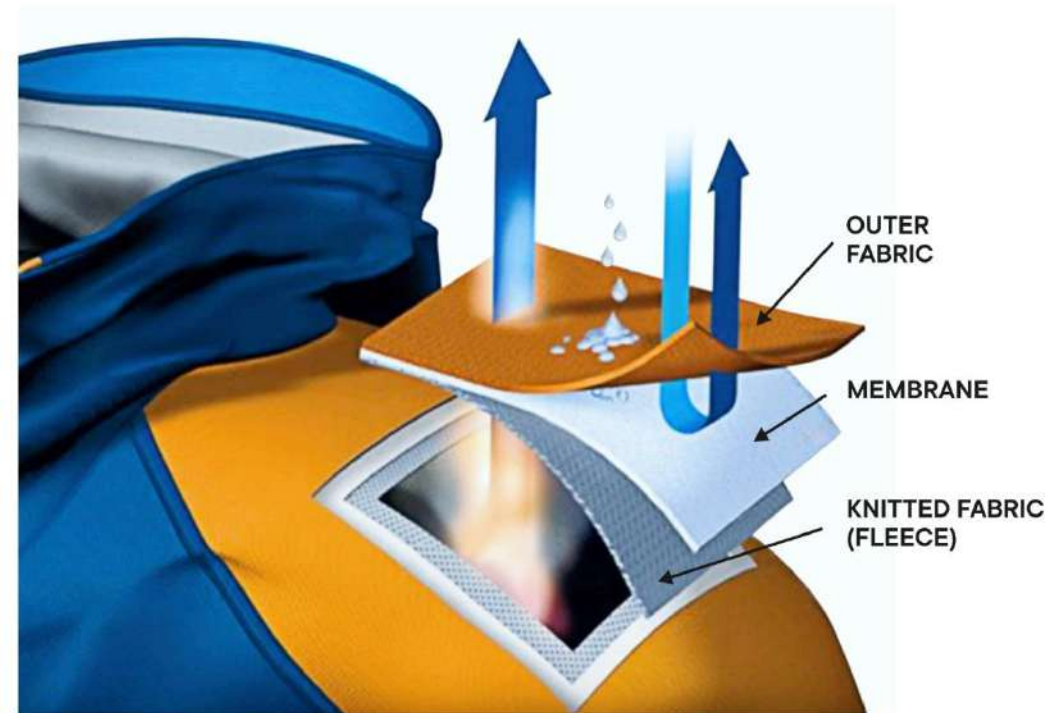
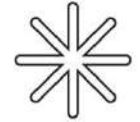

MEMBRANE LAMINATED FABRICS

BREATHABLE MEMBRANE ADHERES TO THE OUTER FABRIC AND FORMS A 2-LAYER STRUCTURE WITH IT

FABRIC + BREATHABLE COATING

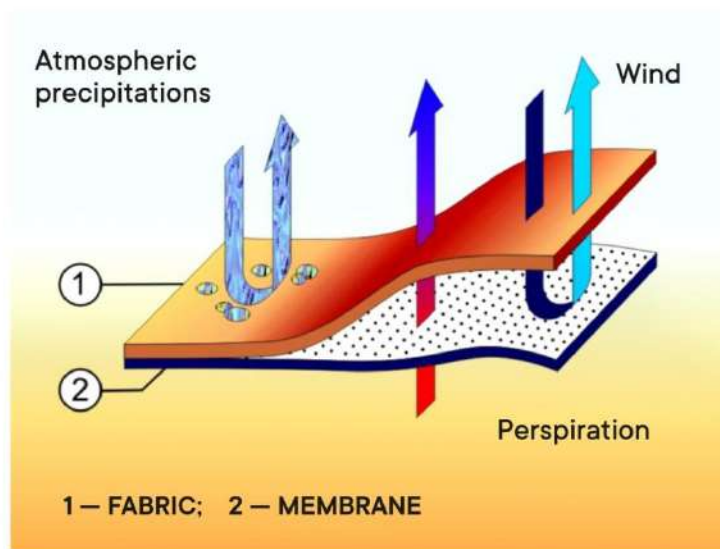

Biocidal protection against mosquitoes and bacteria

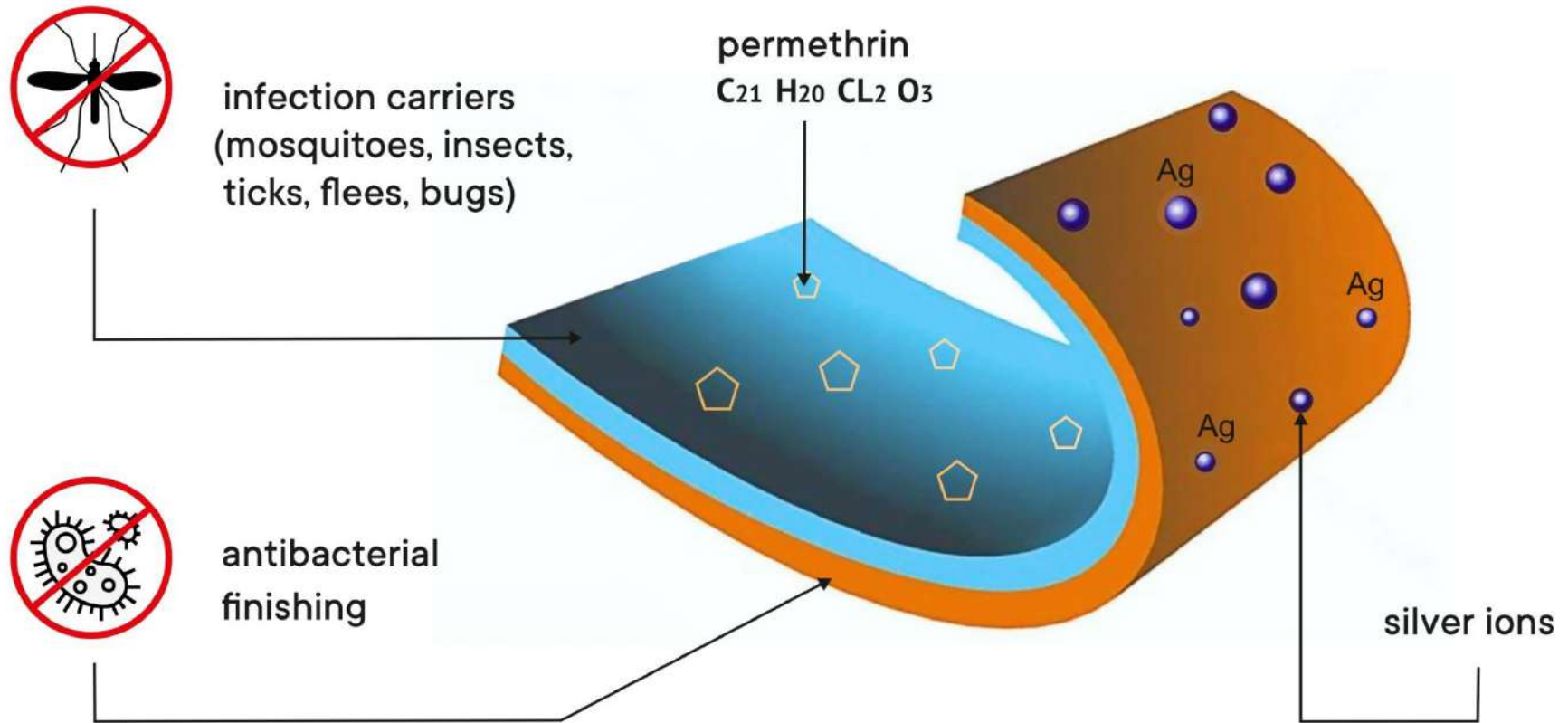

- for table linen
- jacquard decorative fabrics
- voils and curtain fabrics
- knitted fabrics
- upholstery fabrics





TEXTILE THAT WORKS

(M)



MOGOTEX

THE END

www.mogotex.by



PURE LINEN FABRICS

PFD, natural, optic white, dyed, softened, with washed effect

Orsha Linen Mill is one of the major producers of linen fabrics in Europe. The company's products are exported to more than 40 countries of the world. Orsha Linen Mill puts into practice the whole manufacturing cycle from flax fiber processing to production of fabrics with finishing and ready-made goods in compliance with the International quality management system STB ISO 9001-2009.

We offer linen fabrics with unique properties:



BREATHABILITY



SUSTAINABILITY



ABSORBABILITY



ANTIBACTERIAL EFFECT



COOLING EFFECT

OBR 78 PFD

125 gsm
150 cm



PFD optic white dyed col. 1347

OBR 020 color woven

125 gsm
150 cm



dec.44 col.254 des.44 col.133 des.141 col.2

OBR 040 PFD

150 gsm
150 cm



PFD optic white dyed col. 1347

OBR 1402 color woven

180 gsm
150 cm



2 - 61 11 - 133

OBR 491 PFD

185 gsm
150 cm



PFD optic white

OBR 888 MXY color woven

185 gsm
150 cm



1 - 362 1 - 416

OBR 1542 PFD

245 gsm
150 cm



PFD dyed col. 1571

OBR 05158 PFD

265 gsm
150 cm



PFD dyed col. 1571

OBR 1458/1 PFD

280 gsm
150 cm



des. 1 des. 3

OBR 1520 PFD

175 gsm
150 cm



OBR 840 PFD

140 gsm
150 cm



OBR 1471/1 natural

245 gsm
150 cm



OBR 1588 natural

245 gsm
155 cm



OBR 1567 from bleached yarns

120 gsm
145 cm



OBR 482 natural

280 gsm
150 cm



OBR 1237 natural

275 gsm
150 cm



OBR 1566 natural

120 gsm
145 cm



OBR 0465 PFD

125 gsm
150 cm



SEMI-LINEN FABRICS

Orsha Linen Mill is one of the major producers of linen fabrics in Europe. The company's products are exported to more 40 countries around the world.

Orsha Linen Mill has been putting into practice the whole manufacturing cycle from processing of flax fiber to production of finished fabrics and ready-made products according to the International quality management Certificate STB ISO 9001-2009.

We offer linen fabrics with unique properties:



BREATHABILITY



SUSTAINABILITY



ABSORBABILITY



ANTIBACTERIAL EFFECT



COOLING EFFECT

OBR 236 PFD

50% linen 50% cotton
120 gsm
150 cm



OBR 026 natural

51% linen 49% cotton
125 gsm
150 cm



OBR 271 color woven XY

48% linen 52% cotton
125 gsm
150 cm



OBR 045 PFD

56% linen 44% cotton
140 gsm
150 cm



OBR 053 natural

56% linen 44% cotton
145 gsm
150 cm



OBR 1634 PFD

63% linen 73% cotton
145 gsm
150 cm



OBR 1300 PFD

53% linen 47% cotton
175 gsm
150 cm



OBR 1012 natural

58% linen 42% cotton
210 gsm
150 cm



OBR 1753 natural

59% linen 41% cotton
240 gsm
153 cm



JSC «RUCHAIKA»

TECHNICAL AND DECORATIVE FABRICS



JSC «RUCHAİKA» TODAY

- PRODUCES TENT MATERIALS, ROOFING MEMBRANE, MATERIALS FOR MINE VENTILATION, **TECHNICAL AND DECORATIVE FABRICS, GEOTEXTILES**, FINISHED PVC TENT PRODUCTS.
- MORE THAN 60% OF THE COMPANY'S PRODUCTS ARE EXPORTED TO THE CIS COUNTRIES, NEAR AND FAR ABROAD

ABOUT US

ruchaika.by

ABOUT US

- THE ONLY IN THE REPUBLIC OF BELARUS AND ONE OF THE LARGEST IN THE CIS MANUFACTURER OF TENT MATERIALS, MATERIALS FOR MINE VENTILATION, ROOFING MEMBRANE AND WATERPROOFING MATERIALS.
- ONE OF THE LARGEST CIS MANUFACTURERS OF TECHNICAL AND DECORATIVE FABRICS, TENT BACKING FABRICS.

ABOUT US

FABRICS



PRODUCT RANGE

FABRICS

PRODUCT RANGE

PRODUCT RANGE

THE RANGE OF FABRICS

- FABRIC BACKING FOR ARTIFICIAL LEATHER, TABLE AND MEDICAL OILCLOTH
- FABRIC BACKING FOR AWNINGS
- FABRIC BACKING FOR RUBBER TECHNICAL GOODS
- FABRIC FROM HEAT-RESISTANT SYNTHETIC FIBERS
- FABRIC CARCASS FILTER
- DECORATIVE FABRIC
- FABRIC FOR EMBROIDERY

JSC "RUCHAIKA" - THE ONLY COMPANY IN THE REPUBLIC OF BELARUS, SPECIALIZING IN THE PRODUCTION OF TECHNICAL AND DECORATIVE FABRICS, BASE FABRIC FOR PVC.

ASSORTMENT OF FABRICS



PRODUCT RANGE

PRODUCT RANGE

PRODUCT RANGE

DECORATIVE FABRICS

- DECORATIVE FABRICS ARE USED FOR SEWING CLOTHES AND ACCESSORIES
- WIDE RANGE OF DECORATIVE FABRICS:
 - DRY FABRIC
(COMPOSITION: POLYESTER-VISCOSE)
 - DECORATIVE FABRICS
(COMPOSITION: POLYESTER-COTTON-LEN,
POLYESTER-VISCOSE-LEN,
POLYESTER-VISCOSE-VISCOSE)

ASSORTMENT OF FABRICS



DECORATIVE FABRICS

PRODUCT RANGE

PRODUCT RANGE

PRODUCT RANGE

Article	Surface density, g/m ²	Raw material composition	Width, cm
DECORATIVE FABRICS / LINEN FABRICS			
6C-312	201	Polyester/Viscose/Linen 59/32/9	150
24C-564	201	Polyester/Viscose/Linen 59/32/9	150
07C-316	178	Polyester/Viscose/Linen 50/30/20	150
07C-336/2	172	Polyester/Viscose/Linen 59/32/9	150
09C-362	203	Polyester/Viscose/Linen 59/32/9	150
09C-363	162	Polyester/Viscose/Linen 59/32/9	150
24C 570	162	Polyester/Linen/Viscose 60/25/15	150
10C-403	154	Polyester/Viscose/Linen 50/30/20	150
10C-403/1	154	100% Polyester	150

ASSORTMENT OF FABRICS



PRODUCT RANGE

PRODUCT RANGE

PRODUCT RANGE

EMBROIDERY FABRICS

- EMBROIDERY FABRICS ARE USED FOR DECORATION OF CLOTHING AND HOME TEXTILES, USED IN NEEDLEWORK
- WIDE RANGE OF EMBROIDERY FABRICS: THE FABRICS HAVE VARIOUS COMPOSITION (POLYESTER, POLYESTER-COTTON-LINEN), COLOUR AND TEXTURE

ASSORTMENT OF FABRICS



EMBROIDERY FABRICS

Article	Surface density, g/m ²	Raw material composition	Width, cm
EMBROIDERY FABRICS			
0C-93B ап_2	166	100% Polyester	149
0C-93B/1 аппр	166	100% Polyester black	149
0C-97B аппр	191	100% Polyester	149
0C-97B/1 аппр	191	100% Polyester black	149
09C-373/1	183	100% Polyester	149
10C-409 ап 2	193	100% Polyester	150
10C-414/1 ап 2	234	100% Polyester	150
07C-325	189	Polyester/Cotton/Linen 50/30/20	147
22C-547 аппр	189	Polyester/Linen 67/33	147
9C-55B	192	Polyester/Cotton/Linen 50/30/20	150
23C 561	187	Polyester/Cotton/Linen 50/30/20	150
23C 562	190	Polyester/Cotton/Linen 50/30/20	150

PRODUCT RANGE

PRODUCT RANGE

PRODUCT RANGE

ASSORTMENT OF FABRICS



**FABRICS OF HEAT-RESISTANT
SYNTHETIC FIBRES**

PRODUCT RANGE

PRODUCT RANGE

PRODUCT RANGE

- UNIQUE PROPERTIES:
 - THERMAL RESISTANCE AND FIRE RESISTANCE
 - STRENGTH AND WEAR RESISTANCE
 - ELASTICITY
 - LIGHTNESSTHE
- FABRIC IS USED FOR SEWING FIREFIGHTERS, METALLURGISTS, HOT SHOP WORKERS, WELDERS, MAKING THERMAL SLEEVES, ETC.

ASSORTMENT OF FABRICS



TECHNICAL FABRICS

PRODUCT RANGE

PRODUCT RANGE

PRODUCT RANGE

- THE ASSORTMENT OF WEAVING PRODUCTION INCLUDES TECHNICAL FABRICS (ASSORTMENT LIST OF FABRICS IN THE ATTACHMENT):
- - FABRIC BACKING FOR MEDICAL OILCLOTH AND TABLE CLOTH (COMPOSITION: POLYESTER, POLYESTER-COTTON);
- - FABRIC BACKING FOR TENT MATERIALS (COMPOSITION: POLYESTER);
- - FABRIC BACKING FOR GENERAL MECHANICAL RUBBER PRODUCTS (COMPOSITION: POLYESTER-COTTON, POLYESTER);
- - FABRICS FOR SEWING BAG FILTERS (COMPOSITION: POLYESTER);
- - FILTER FABRICS FOR THE DAIRY INDUSTRY (COMPOSITION: POLYESTER).

FABRICS

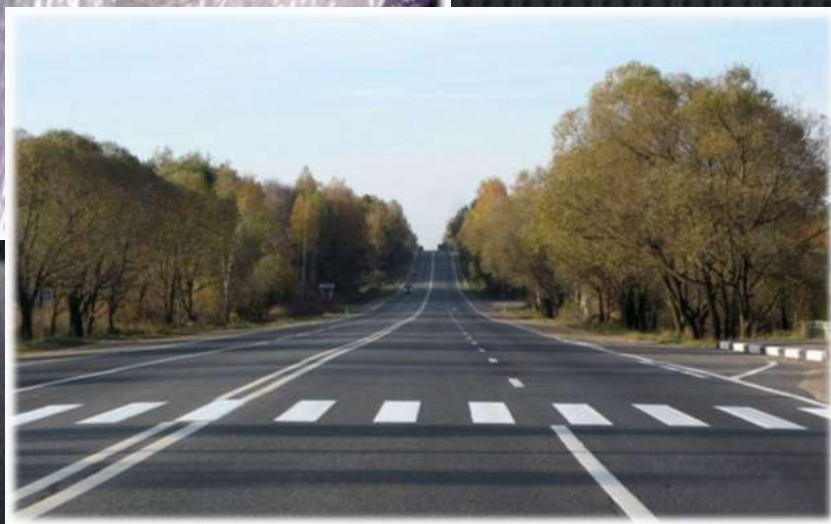
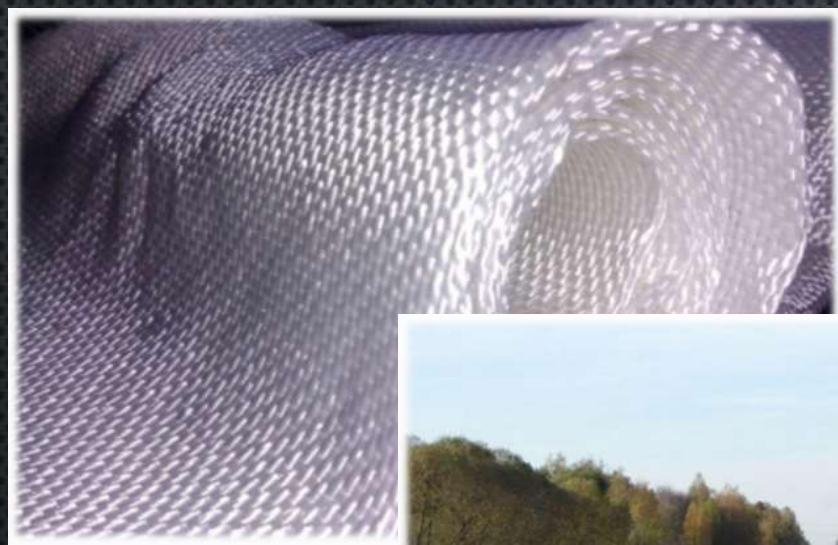

PRODUCT RANGE

GEOTEXTILE

PRODUCT RANGE

GEOTEXTILE

- ONE OF THE MOST PROMISING MATERIALS FOR THE REINFORCEMENT OF SOIL MASSES DURING THE CONSTRUCTION OF ROADS AND RAILWAYS IS A HIGHSTRENGTH GEOTEXTILE.
- JSC "RUCHAIKA" STARTED PRODUCTION OF GEOTEXTILES WITH HIGH TENSILE CHARACTERISTICS, GOOD PERMEABILITY, EXCELLENT FILTRATION THAT ALLOW TO WITHSTAND HEAVY LOADS WITHOUT SIGNIFICANTLY INCREASING THE LENGTH.
- THANKS TO ITS TECHNICAL CHARACTERISTICS, GEOTEXTILE IS WIDELY USED IN CONSTRUCTION TO IMPROVE THE BEARING CAPACITY AND STRENGTH OF THE SOIL BASES AND FACILITIES.



JSC «RUCHAIKA»



**TECHNICAL AND
DECORATIVE FABRICS**

CONTACT DETAIL

ruchaika.by

CONTACT DETAILS

CONTACT US TO DISCUSS TERMS



www.ruchaika.by



139-7 Sovetskaya str.
Brest region, Kobrin
225304, Republic of Belarus



+375 1642 3 44 06
+375 33 637 18 36
+375 29 692 24 73



market@ruchaika.by

CONTACT DETAILS

JSC «RUCHAIKA»

QUALITY TRADITIONS. MODERN TECHNOLOGY.

JSC «RUCHAIKA»



JSC «RUCHAIKA» TODAY

- PRODUCES TENT MATERIALS, ROOFING MEMBRANE, TECHNICAL AND DECORATIVE FABRICS, GEOTEXTILES, FINISHED PVC TENT PRODUCTS.
- MORE THAN 60% OF THE COMPANY'S PRODUCTS ARE EXPORTED TO THE CIS COUNTRIES, NEAR AND FAR ABROAD

ABOUT US

ruchaika.by

ABOUT US

- THE ONLY IN THE REPUBLIC OF BELARUS AND ONE OF THE LARGEST IN THE CIS MANUFACTURER OF TENT MATERIALS, MATERIALS FOR MINE VENTILATION, ROOFING MEMBRANE AND WATERPROOFING MATERIALS.
- ONE OF THE LARGEST CIS MANUFACTURERS OF TECHNICAL AND DECORATIVE FABRICS, TENT BACKING FABRICS.

ABOUT US



ruchaika.by

JSC «RUCHAİKA»



PRODUCT RANGE

- TECHNICAL AND DECORATIVE FABRICS
- AWNING MATERIALS
- MATERIAL FOR MINE VENTILATION
- ROOFING MEMBRANE
- WATERPROOFING MATERIAL
- PRODUCTS MADE OF TENT FABRIC

PRODUCT RANGE

PRODUCT RANGE

PRODUCT RANGE

FABRICS



PRODUCT RANGE

FABRICS

PRODUCT RANGE

PRODUCT RANGE

THE RANGE OF FABRICS

- FABRIC BACKING FOR ARTIFICIAL LEATHER, TABLE AND MEDICAL OILCLOTH
- FABRIC BACKING FOR AWNINGS
- FABRIC BACKING FOR RUBBER TECHNICAL GOODS
- FABRIC FROM HEAT-RESISTANT SYNTHETIC FIBERS
- FABRIC CARCASS FILTER
- DECORATIVE FABRIC
- FABRIC FOR EMBROIDERY

JSC "RUCHAIKA" - THE ONLY COMPANY IN THE REPUBLIC OF BELARUS, SPECIALIZING IN THE PRODUCTION OF TECHNICAL AND DECORATIVE FABRICS, BASE FABRIC FOR PVC.



FABRICS



PRODUCT RANGE

GEOTEXTILE

PRODUCT RANGE

ruchaika.by

GEOTEXTILE

- ONE OF THE MOST PROMISING MATERIALS FOR THE REINFORCEMENT OF SOIL MASSES DURING THE CONSTRUCTION OF ROADS AND RAILWAYS IS A HIGHSTRENGTH GEOTEXTILE.
- JSC "RUCHAIKA" STARTED PRODUCTION OF GEOTEXTILES WITH HIGH TENSILE CHARACTERISTICS, GOOD PERMEABILITY, EXCELLENT FILTRATION THAT ALLOW TO WITHSTAND HEAVY LOADS WITHOUT SIGNIFICANTLY INCREASING THE LENGTH.
- THANKS TO ITS TECHNICAL CHARACTERISTICS, GEOTEXTILE IS WIDELY USED IN CONSTRUCTION TO IMPROVE THE BEARING CAPACITY AND STRENGTH OF THE SOIL BASES AND FACILITIES.

TENT MATERIAL



TENT MATERIAL

PRODUCT RANGE

TENT MATERIAL

- THE PRODUCTION CYCLE OF TENT MATERIAL CONSISTS OF THE FOLLOWING STAGES: WEAVING OF BASES, APPLICATION OF PVC COMPOSITION. TENT MATERIAL CAN BE PRODUCED IN VARIOUS DENSITIES: FROM 450 TO 1300 G/M² WITH DIFFERENT CHARACTERISTICS.
- PRODUCTION OF PVC MATERIALS IS CARRIED OUT ON MODERN EQUIPMENT OF ISOTEX (ITALY).

TENT MATERIAL

- 1 - reinforcing fabric**
- 2 - base coat**
- 3 - PVC coating**
- 4 - varnish**

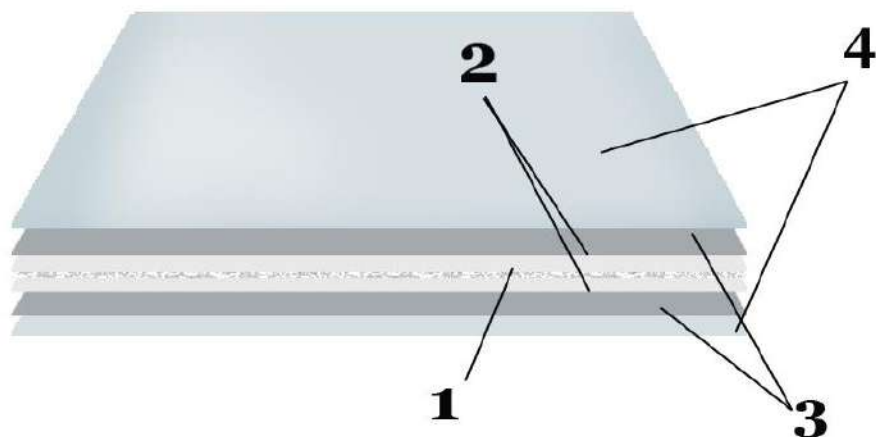

TENT MATERIAL

PRODUCT RANGE

TENT MATERIAL

- TENT MATERIAL "RUCHAIKA" IS A THREE-LAYER PVC MATERIAL. THE BASIS OF THE MATERIAL IS A FABRIC MADE OF POLYESTER TECHNICAL THREADS. THE BASE IS COATED ON BOTH SIDES WITH A PVC COMPOSITION, ADDITIONALLY IT CAN BE VARNISHED ON ONE OR TWO SIDES.
- PVC RESIN GIVES THE MATERIAL DURABILITY. THE MATERIAL HAS EXCELLENT LIGHT FASTNESS.



TENT MATERIAL



ruchaika.by

APPLICATION OF PVC TENT MATERIALS

- PRODUCTION OF ARCHITECTURAL AND FRAME STRUCTURES, FRAME TENT STRUCTURES, LARGE HANGARS, LARGE SHEDS, OUTDOOR CAFES, PAVILIONS, TEMPORARY STORAGE WAREHOUSES;
- PRODUCTION OF CAR COVERS, HANGARS, INFLATABLE BOATS, INFLATABLE TRAMPOLINES, ATTRACTIONS, TUBING (CHEESECAKES);
- FOR CANOPIES, CURTAINS, SHELTERS AND OTHER TECHNICAL PURPOSES.

TENT MATERIAL

PRODUCT RANGE

TENT MATERIAL

THE RANGE OF TENT MATERIALS



TENT MATERIAL

TENT MATERIAL

PRODUCT RANGE

TENT MATERIAL

- FOR CURTAINS, BLINDS WITHOUT LACQUER
- FOR CAR COVERS, WITH ONE-SIDED LACQUER
- FOR ARCHITECTURAL AND FRAME STRUCTURES WITH 2-SIDED LACQUER
- FOR ARCHITECTURAL AND FRAME STRUCTURES WITH 2-SIDED LACQUER. FROST-RESISTANT (UP TO 50 °C)
- FOR ARCHITECTURAL AND FRAME STRUCTURES WITH 2-SIDED LACQUER. FIRE-RESISTANT (G1-G2)



TENT MATERIAL «RUCHAIKA»



TENT MATERIAL

PRODUCT RANGE

TENT MATERIAL

ADVANTAGES

- OPTIMALLY COMBINES THE RELIABILITY, STRENGTH AND ELASTICITY;
- NON-TOXIC, NO ADVERSE EFFECTS ON THE HUMAN BODY;
- POSSIBILITY TO MANUFACTURE MATERIALS IN ACCORDANCE WITH ALL PHYSICAL AND MECHANICAL PROPERTIES APPLIED BY THE CUSTOMER;
- RESISTANT TO PETROL AND OILS;
- ABILITY TO PRINT WITH SOLVENT INK ON THE TENT;
- WIDE RANGE OF COLORS ACCORDING TO THE CATALOG RAL COLORS OR AS AGREED WITH THE CUSTOMER;
- WIDTH OF ROLLS CAN BE FROM 2,5 M TO 3,2 M.



ROOFING MEMBRANES



ROOFING MATER

ruchaika.by

PRODUCT RANGE

- ROOFING MATERIAL "RUCHAIKA" - IS REINFORCED WITH POLYESTER MATERIAL WITH A THREE-LAYER APPLICATION OF PVC COMPOSITIONS, COATED ON BOTH SIDES WITH VARNISH.
- ROOFING MATERIAL "RUCHAIKA" IS INTENDED FOR INSTALLATION AND REPAIR OF SINGLE-LAYER COATING UNEXPLOITED ROOFS OF BUILDINGS AND STRUCTURES FOR VARIOUS PURPOSES: INDUSTRIAL, PUBLIC AND RESIDENTIAL, AS WELL AS FOR WATERPROOFING OF GROUND STORAGE TANK COATINGS, LANDFILLS, AND OTHER TECHNICAL PURPOSES.

DFING MATERIAL

ROOFING MEMBRANES



ROOFING MATER

PRODUCT RANGE

ROOFING MATERIAL



- THE RELATIVE EASE OF THE MATERIAL (1350 G/ M²)



- EASY TO STACK



- MAINTAINABILITY THROUGHOUT MAINTENANCE PERIOD



- ROOF INSTALLATION IS CARRIED OUT WITHOUT THE USE OF FIRE AND POSSIBLE AT ANY TIME OF THE YEAR



- RESISTANCE TO UV RADIATION



- IMPERMEABILITY



- HIGH FROST RESISTANCE



- HIGH RESISTANCE TO COMBUSTION (G1)



- LONG MAINTENANCE PERIOD

- GUARANTEED MAINTENANCE PERIOD - 15 YEARS

MATERIAL FOR MINE VENTILATION



MATERIAL FOR MINE VENTILATION

PRODUCT RANGE

ruchaika.by

- IT IS DESIGNED FOR SEWING SUPPLY SIGNIFICANT VOLUMES OF AIR HOSES WITH BLOWING VENTILATION IN THE MINE, TUNNELS. VENTILATION PIPES CAN BE USED FOR MANY YEARS, OFTEN OUTWEIGHING, WITHOUT COMPROMISING ON QUALITY, THANKS TO THE USE OF HIGH-STRENGTH THREADS, PREVENTING BREAKAGE.
- FIRE RETARDANT COMPOSITE MATERIAL PROVIDES FLAME RESISTANCE AND ENSURES STABLE PERFORMANCE IN THE TEMPERATURE RANGE FROM -30°C TO $+70^{\circ}\text{C}$ AND DOES NOT DEPEND ON THE ENVIRONMENTAL CONDITIONS. DUE TO LOWER AIR RESISTANCE AND LESS LOSS OF PRESSURE HOSE OF A MATERIAL FOR MINE VENTILATION SAVES ENERGY BY 10-20%.

RANGE OF PRODUCTS



TENT MATERIAL

PRODUCT RANGE

TENT MATERIAL

MADE OF TENT FABRIC

- CAR COVERS
- ARCHITECTURAL STRUCTURES
- CURTAINS
- QUICKLY ERECTABLE STRUCTURES
- PAVILIONS
- FRAME TENT STRUCTURES

CERTIFICATES



- THE HIGH LEVEL OF ORGANIZATION OF MATERIAL'S PRODUCTION, CONFIRMED BY A CERTIFICATE OF CONFORMITY OF QUALITY MANAGEMENT SYSTEM STB ISO 9001-2009. YEARS OF EXPERIENCE, QUALIFIED PERSONNEL, EFFICIENT USE OF PROCESSING EQUIPMENT, COOPERATION WITH DOMESTIC AND FOREIGN BUSINESS PARTNERS, ALLOW THE COMPANY TO PRODUCE A WIDE RANGE OF HIGH QUALITY TEXTILE AND TECHNICAL MATERIALS.

- JSC "RUCHAIKA" TWICE BECAME THE WINNER OF THE REPUBLICAN PROFESSIONAL CONTEST "BEST BUILDING PRODUCT OF THE YEAR". IN 2013, 2015, 2018, AS A RESULT OF THE CONCLUSION OF THE EXPERT COUNCIL TENT AND ROOFING MATERIAL MANUFACTURED BY JSC "RUCHAIKA" WON THE CONTEST IN THE NOMINATION "THE BEST BUILDING MATERIAL (PRODUCT) OF THE YEAR".



JSC «RUCHAIKA»



TENT MATERIAL

CONTACT DETAILS

ruchaika.by

CONTACT US TO DISCUSS TERMS



www.ruchaika.by



139-7 Sovetskaya str.
Brest region, Kobrin
225304, Republic of Belarus



+375 1642 3 44 06
+375 33 637 18 36
+375 29 692 24 73



market@ruchaika.by

CONTACT DETAILS

JSC «RUCHAIKA»

QUALITY TRADITIONS. MODERN TECHNOLOGY.

COMMERCIAL OFFER

— HOME —

BLAKIT

— 1963 —

SATIN BEDDING SETS

BEDDING SETS STRIPE SATIN

ITEM	SIZE AND COMPOSITION	PRICES, EUR
4247/1	SINGLE BEDDING SET (DUVET COVER SIZE 215*153CM; SHEET SIZE 220*145CM; PILLOWCASE SIZE 50*70CM - 2PCS)	
4248/1	SINGLE BEDDING SET (DUVET COVER SIZE 215*153; SHEET SIZE 220*145CM; PILLOWCASE SIZE 70*70 - 2PCS)	
4249/1	DOUBLE BEDDING SET (DUVET COVER SIZE 240*220CM; SHEET SIZE 240*220CM; PILLOWCASE SIZE - 50*70 - 2PCS)	
4250/1	DOUBLE BEDDING SET (DUVET COVER SIZE 240*220CM; SHEET SIZE 240*220CM; PILLOWCASE SIZE - 70*70 - 2PCS)	
4251/1	EURO BEDDING SET (DUVET COVER SIZE 225*215CM; SHEET SIZE 240*220CM; PILLOWCASE SIZE - 50*70 - 2PCS)	
4252/1	EURO BEDDING SET (DUVET COVER SIZE 225*215CM; SHEET SIZE 240*220CM; PILLOWCASE SIZE - 70*70 - 2PCS)	
4253/1	DUET BEDDING SET (DUVET COVER SIZE 215*153CM - 2PCS; SHEET SIZE 240*220CM; PILLOWCASE SIZE - 50*70 - 2PCS)	
4254/1	1DUET BEDDING SET (DUVET COVER SIZE 215*153CM - 2PCS; SHEET SIZE 240*220CM; PILLOWCASE SIZE - 70*70 - 2PCS)	

COMPOSITION: 100% COTTON

WIDTH: 220 CM

GSM: 125 GRMS

FABRIC WEAVE: COMBINATION
WEAVE



PACKAGE SIZE: 35/26,5 CM

IN ONE CARTON: 5 PCS

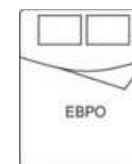

PACKAGE SIZE: 35/26,5 CM

IN ONE CARTON: 4 PCS



PACKAGE SIZE: 35/26,5 CM

IN ONE CARTON: 4 PCS

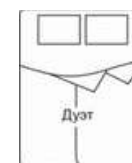

PACKAGE SIZE: 35/26,5 CM

IN ONE CARTON: 3PCS





BEDDING SETS STRIPE SATIN FROM FABRIC ART.12871 (3928)

4247/1 single bedding set: duvet cover size: 215*153cm; sheet size: 220*145cm; pillowcase size:50*70cm

4248/1 single bedding set: duvet cover size: 215*153cm; sheet size: 220*145cm; pillowcase size:70*70cm

4249/1 double bedding set: duvet cover size: 215*175cm; sheet size: 220*240cm; pillowcase size:50*70cm

4250/1 double bedding set: duvet cover size: 215*175cm; sheet size: 220*240cm; pillowcase size:70*70cm

4251/1 euro bedding set: duvet cover size: 215*225cm; sheet size: 220*240cm; pillowcase size:50*70cm

4252/1 euro bedding set: duvet cover size: 215*225cm; sheet size: 220*240cm; pillowcase size:70*70cm

4253/1 duet bedding set: duvet cover size: 215*153cm - 2pcs; sheet size: 220*240cm; pillowcase size:50*70cm

4254/1 duet bedding set: duvet cover size: 215*153cm - 2pcs; sheet size: 220*240cm; pillowcase size:70*70cm



14-3710



17-6323



17-1230

STRIPE SIZE: 1X1 CM



18-0627



19-2520



19-3905



14-4501



18-0202



16-1510

BEDDING SETS STRIPE SATIN FROM FABRIC ART.12872 (3930)

4247/1 single bedding set: duvet cover size: 215*153cm; sheet size: 220*145cm; pillowcase size:50*70cm

4248/1 single bedding set: duvet cover size: 215*153cm; sheet size: 220*145cm; pillowcase size:70*70cm

4249/1 double bedding set: duvet cover size: 215*175cm; sheet size: 220*240cm; pillowcase size:50*70cm

4250/1 double bedding set: duvet cover size: 215*175cm; sheet size: 220*240cm; pillowcase size:70*70cm

4251/1 euro bedding set: duvet cover size: 215*225cm; sheet size: 220*240cm; pillowcase size:50*70cm

4252/1 euro bedding set: duvet cover size: 215*225cm; sheet size: 220*240cm; pillowcase size:70*70cm

4253/1 duet bedding set: duvet cover size: 215*153cm - 2pcs; sheet size: 220*240cm; pillowcase size:50*70cm

4254/1 duet bedding set: duvet cover size: 215*153cm - 2pcs; sheet size: 220*240cm; pillowcase size:70*70cm

STRIPE SIZE 2X2CM



STRIPE SATIN BLEACHED

100% COTTON
ARTICLE FABRIC 12871, 12872
COMBINATION WEAVE
125 GRMS

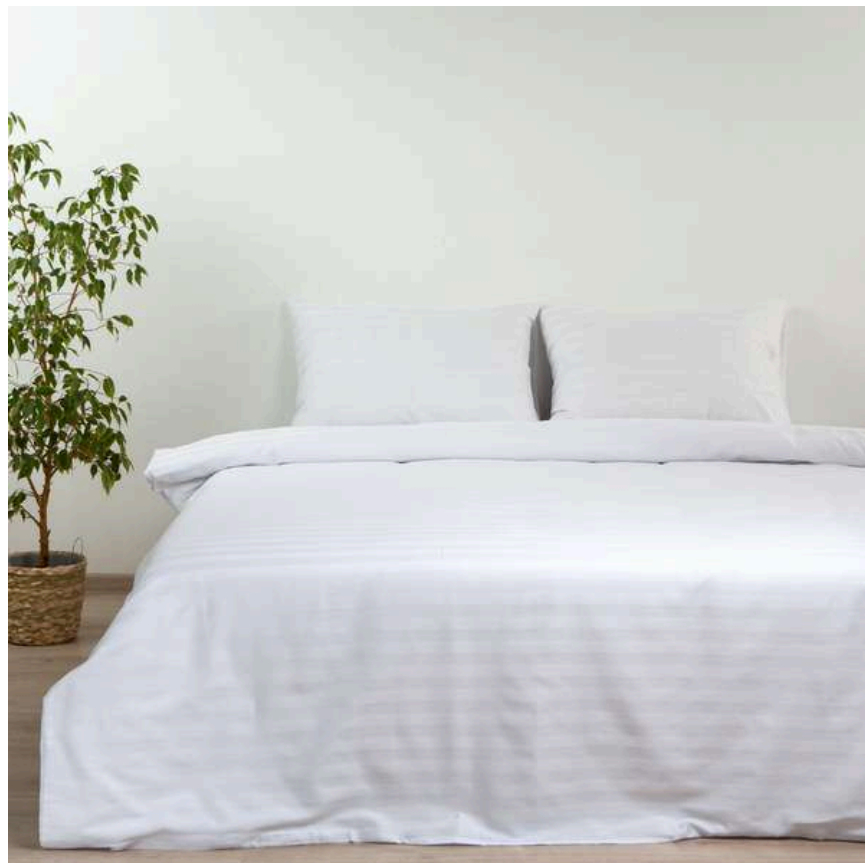

ITEM	SIZE AND COMPOSITION	PRICES, EUR
4234/1	single bedding set: duvet cover size: 215*153cm; sheet size: 220*145cm; pillowcase size:50*70cm - 2pcs	
4235/1	single bedding set: duvet cover size: 215*153cm; sheet size: 220*145cm; pillowcase size:70*70cm - 2pcs	
4236/1	double bedding set: duvet cover size: 215*175cm; sheet size: 240*220cm; pillowcase size:50*70cm - 2pcs	
4237/1	double bedding set: duvet cover size: 215*175cm; sheet size: 240*220cm; pillowcase size:70*70cm - 2pcs	
4238/1	euro bedding set: duvet cover size: 225*215cm; sheet size: 240*220cm; pillowcase size:50*70cm - 2pcs	
4239/1	euro bedding set: duvet cover size: 225*215cm; sheet size: 240*220cm; pillowcase size:70*70cm - 2pcs	
4240/1	duet bedding set: duvet cover size: 215*153cm - 2pcs; sheet size: 240*220cm; pillowcase size:50*70cm - 2pcs	
4241/1	duet bedding set: duvet cover size: 215*153cm - 2pcs; sheet size: 240*220cm; pillowcase size:70*70cm - 2pcs	

STRIPE SIZE 1X1 CM

STRIPE SIZE 2X2 CM

SATIN BEDDING SETS DIGITAL PRINTING

ITEM	SIZE AND COMPOSITION	PRICES, EUR
4508	single bedding set: duvet cover size: 215*153cm; sheet size: 220*145cm; pillowcase size:50*70cm - 2pcs	
4509	single bedding set: duvet cover size: 215*153cm; sheet size: 220*145cm; pillowcase size:70*70cm - 2pcs	
4510	double bedding set: duvet cover size: 215*175cm; sheet size: 240*220cm; pillowcase size:50*70cm - 2pcs	
4511	double bedding set: duvet cover size: 215*175cm; sheet size: 240*220cm; pillowcase size:70*70cm - 2pcs	
4512	euro bedding set: duvet cover size: 225*215cm; sheet size: 240*220cm; pillowcase size:50*70cm - 2pcs	
4513	euro bedding set: duvet cover size: 225*215cm; sheet size: 240*220cm; pillowcase size:70*70cm - 2pcs	
4514	duet bedding set: duvet cover size: 215*153cm - 2pcs; sheet size: 240*220cm; pillowcase size:50*70cm - 2pcs	
4515	duet bedding set: duvet cover size: 215*153cm - 2pcs; sheet size: 240*220cm; pillowcase size:70*70cm - 2pcs	



ARTICLE FABRIC 1287 (2672)
PRINTED/1287 (2679) DYED
COMPOSITION: 100% COTTON
WIDTH: 220 CM
GSM: 125 GRMS FABRIC
WEAVE: ATLAS 5/2



D28/15-1512



D34/19-1955



D37/18-3930



D21/18-5610



D39/14-4105

JACQUARD BEDDING SETS

ITEM	SIZE AND COMPOSITION	PRICES, EUR
4526	double bedding set: duvet cover size: 215*175cm; sheet size: 240*220cm; pillowcase size:70*70cm - 2pcs	
4527	euro bedding set: duvet cover size: 225*215cm; sheet size: 240*220cm; pillowcase size:70*70cm - 2pcs	
4528	duet bedding set: duvet cover size: 215*153cm - 2pcs; sheet size: 240*220cm; pillowcase size:70*70cm - 2pcs	



BLEACHED



DYED 11-0606



ARTICLE FABRIC 407404 (3718)

BLEACHED/407404 (3877) DYED

COMPOSITION: 100% COTTON

WIDTH: 290 CM

GSM: 145 GRMS

FABRIC WEAVE: COMBINATION WEAVE

JACQUARD BEDDING SETS

ITEM	SIZE AND COMPOSITION	PRICES, EUR
4526	double bedding set: duvet cover size: 215*175cm; sheet size: 240*220cm; pillowcase size:70*70cm - 2pcs	
4527	euro bedding set: duvet cover size: 225*215cm; sheet size: 240*220cm; pillowcase size:70*70cm - 2pcs	
4528	duet bedding set: duvet cover size: 215*153cm - 2pcs; sheet size: 240*220cm; pillowcase size:70*70cm - 2pcs	



BLEACHED



DYED 16-1509

ARTICLE FABRIC 407403 (3717) BLEACHED/407403 (3876) DYED

COMPOSITION: 100% COTTON

WIDTH: 290 CM

GSM: 145 GRMS

FABRIC WEAVE: COMBINATION WEAVE

JACQUARD BEDDING SETS

ITEM	SIZE AND COMPOSITION	PRICES, EUR
4526	double bedding set: duvet cover size: 215*175cm; sheet size: 240*220cm; pillowcase size:70*70cm - 2pcs	
4527	euro bedding set: duvet cover size: 225*215cm; sheet size: 240*220cm; pillowcase size:70*70cm - 2pcs	
4528	duet bedding set: duvet cover size: 215*153cm - 2pcs; sheet size: 240*220cm; pillowcase size:70*70cm - 2pcs	



BLEACHED



DYED

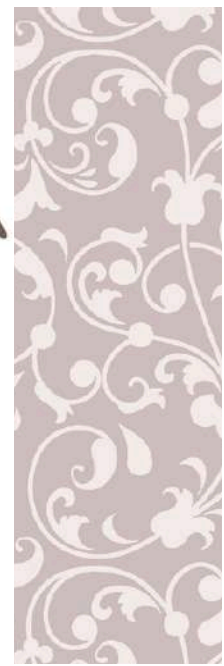

ARTICLE FABRIC 4143 (4411)
 BLEACHED/4143 (4412) DYED
 COMPOSITION: 100% COTTON
 WIDTH: 290 CM
 GSM: 145 GRMS
 FABRIC WEAVE: COMBINATION WEAVE

OFFER FROM

— HOME —

BLAKIT

— 1963 —

CALICO BEDDING SETS

Bedding sets

Item	Size and composition	Price, EUR
2380/0	Single bedding set (duvet cover 215*153 cm, sheet 220*150 cm, pillowcase 70*70 cm 1 pc)	
41241/0	Single bedding set (duvet cover 215*153 cm, sheet 220*145 cm, pillowcase 70*70 cm 2 pcs)	
41242/0	Single bedding set (duvet cover 215*153 cm, sheet 220*145 cm, pillowcase 50*70 cm 2 pcs)	
41251/0	Double bedding set (duvet cover 215*175 cm, sheet 220*210 cm, pillowcase 70*70 cm 2 pcs)	
41252/0	Double bedding set (duvet cover 215*175 cm, sheet 220*210 cm, pillowcase 50*70 cm 2 pcs)	
41261/0	Euro bedding set (duvet cover 225*215 cm, sheet 240*220 cm, pillowcase 70*70 cm 2 pcs)	
41262/0	Euro bedding set (duvet cover 225*215 cm, sheet 240*220 cm, pillowcase 50*70 cm 2 pcs)	
41271/0	Duet bedding set (duvet cover 215*153 cm 2 pcs, sheet 240*220 cm, pillowcase 70*70 cm 2 pcs)	
41272/0	Duet bedding set (duvet cover 215*153 cm 2 pcs, sheet 240*220 cm, pillowcase 50*70 cm 2 pcs)	

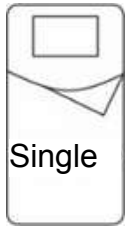

Single

Package size: 35/26,5 cm
Gross weight: 1,8 kg
In one cartone: 5 pcs

fabric composition: 100% cotton
width: 220 cm
weight: 118 gsm

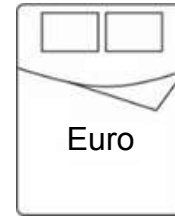

Euro

Package size: 35/26,5 cm
Gross weight: 2,4 kg
In one cartone: 4 pcs

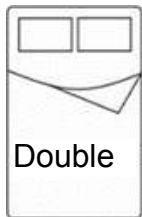

Double

Package size: 35/26,5 cm
Gross weight: 2,2 kg
In one cartone: 4 pcs

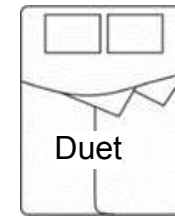

Duet

Package size: 35/26,5 cm
Gross weight: 2,8 kg
In one cartone: 3 pcs

Bedding items

Item	Size and composition	Price, EUR
47/0	Pillowcase 70*70 cm	
1028/0	Pillowcase 50*70 cm	
113/0	Duvet cover 215*153 cm	
116/0	Duvet cover 215*175 cm	
118/0	Duvet cover 225*215 cm	
1378/0	Sheet 220*145 cm	
1375/0	Sheet 220*180 cm	
1381/0	Sheet 220*210 cm	
1383/0	Sheet 240*220 cm	
2984/0	Fitted sheet 200*90*25 cm	
2957/0	Fitted sheet 200*140*25 cm	
2983/0	Fitted sheet 200*160*25 cm	
2994/0	Fitted sheet 200*180*25 cm	
2977/0	Fitted sheet 220*200*25 cm	

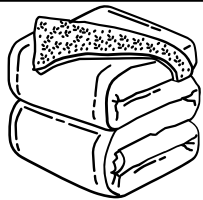

duvet covers
In one cartone:
art.113/0 - 6 pcs
art.116/0 - 6 pcs
art.118/0 - 4 pcs



pillowcases
In one cartone:
art.47/0 - 30 pcs
art.1028/0 - 30 pcs



sheet
In one cartone:
art.1378/0 - 10 pcs
art.1375/0 - 9 pcs
art.1381/0 - 9 pcs
art.1383/0 - 6 pcs
art.2984/0 - 7 pcs
art.2957/0 - 7 pcs
art.2983/0 - 7 pcs
art.2994/0 - 7 pcs
art.2977/0 - 7 pcs



Детские товары не подлежат возврату. Товары, имеющие маркировку «Не подлежит возврату».

HOME

BLAKIT

1963

CALICO BEDDING SETS

Art.41241/0 (Single duvet cover 215*153 cm, sheet 220*145 cm, pillowcase 70*70 cm)

Art.41242/0 (Single duvet cover 215*153 cm, sheet 220*145 cm, pillowcase 50*70 cm)

Art.41251/0 (Double duvet cover 215*175 cm, sheet 220*210 cm, pillowcase 70*70 cm)

Art.41252/0 (Double duvet cover 215*175 cm, sheet 220*210 cm, pillowcase 50*70 cm)

Art.41261/0 (Euro duvet cover 215*225 cm, sheet 220*240 cm, pillowcase 70*70 cm)

Art.41262/0 (Euro duvet cover 215*225 cm, sheet 220*240 cm, pillowcase 50*70 cm)

Art.41271/0 (Duet duvet cover 215*153 cm 2 pcs, sheet 220*240 cm, pillowcase 70*70 cm)

Art.41272/0 (Duet duvet cover 215*153 cm 2 pcs, sheet 220*240 cm, pillowcase 50*70 cm)



5870.01/5926.44



5870.02/5871.02

HOME

BLAKIT

1963

CALICO BEDDING SETS

- Art.41241/0 (Single duvet cover 215*153 cm, sheet 220*145 cm, pillowcase 70*70 cm)
- Art.41242/0 (Single duvet cover 215*153 cm, sheet 220*145 cm, pillowcase 50*70 cm)
- Art.41251/0 (Double duvet cover 215*175 cm, sheet 220*210 cm, pillowcase 70*70 cm)
- Art.41252/0 (Double duvet cover 215*175 cm, sheet 220*210 cm, pillowcase 50*70 cm)
- Art.41261/0 (Euro duvet cover 215*225 cm, sheet 220*240 cm, pillowcase 70*70 cm)
- Art.41262/0 (Euro duvet cover 215*225 cm, sheet 220*240 cm, pillowcase 50*70 cm)
- Art.41271/0 (Duet duvet cover 215*153 cm 2 pcs, sheet 220*240 cm, pillowcase 70*70 cm)
- Art.41272/0 (Duet duvet cover 215*153 cm 2 pcs, sheet 220*240 cm, pillowcase 50*70 cm)



6377.02/5926.41



6584.01/4579.85

HOME

BLAKIT

1963

CALICO BEDDING SETS

Art.41241/0 (Single duvet cover 215*153 cm, sheet 220*145 cm, pillowcase 70*70 cm)

Art.41242/0 (Single duvet cover 215*153 cm, sheet 220*145 cm, pillowcase 50*70 cm)

Art.41251/0 (Double duvet cover 215*175 cm, sheet 220*210 cm, pillowcase 70*70 cm)

Art.41252/0 (Double duvet cover 215*175 cm, sheet 220*210 cm, pillowcase 50*70 cm)

Art.41261/0 (Euro duvet cover 215*225 cm, sheet 220*240 cm, pillowcase 70*70 cm)

Art.41262/0 (Euro duvet cover 215*225 cm, sheet 220*240 cm, pillowcase 50*70 cm)

Art.41271/0 (Duet duvet cover 215*153 cm 2 pcs, sheet 220*240 cm, pillowcase 70*70 cm)

Art.41272/0 (Duet duvet cover 215*153 cm 2 pcs, sheet 220*240 cm, pillowcase 50*70 cm)



6013.01/4993.15



6327.01/5873.13

HOME

BLAKIT

1963

CALICO BEDDING SETS

Art.41241/0 (Single duvet cover 215*153 cm, sheet 220*145 cm, pillowcase 70*70 cm)

Art.41242/0 (Single duvet cover 215*153 cm, sheet 220*145 cm, pillowcase 50*70 cm)

Art.41251/0 (Double duvet cover 215*175 cm, sheet 220*210 cm, pillowcase 70*70 cm)

Art.41252/0 (Double duvet cover 215*175 cm, sheet 220*210 cm, pillowcase 50*70 cm)

Art.41261/0 (Euro duvet cover 215*225 cm, sheet 220*240 cm, pillowcase 70*70 cm)

Art.41262/0 (Euro duvet cover 215*225 cm, sheet 220*240 cm, pillowcase 50*70 cm)

Art.41271/0 (Duet duvet cover 215*153 cm 2 pcs, sheet 220*240 cm, pillowcase 70*70 cm)

Art.41272/0 (Duet duvet cover 215*153 cm 2 pcs, sheet 220*240 cm, pillowcase 50*70 cm)



3581.03/5873.18



5778.02/5942.39

HOME

BLAKIT

1963

CALICO BEDDING SETS

Art.41241/0 (Single duvet cover 215*153 cm, sheet 220*145 cm, pillowcase 70*70 cm)

Art.41242/0 (Single duvet cover 215*153 cm, sheet 220*145 cm, pillowcase 50*70 cm)

Art.41251/0 (Double duvet cover 215*175 cm, sheet 220*210 cm, pillowcase 70*70 cm)

Art.41252/0 (Double duvet cover 215*175 cm, sheet 220*210 cm, pillowcase 50*70 cm)

Art.41261/0 (Euro duvet cover 215*225 cm, sheet 220*240 cm, pillowcase 70*70 cm)

Art.41262/0 (Euro duvet cover 215*225 cm, sheet 220*240 cm, pillowcase 50*70 cm)

Art.41271/0 (Duet duvet cover 215*153 cm 2 pcs, sheet 220*240 cm, pillowcase 70*70 cm)

Art.41272/0 (Duet duvet cover 215*153 cm 2 pcs, sheet 220*240 cm, pillowcase 50*70 cm)



6399.01/5926.41



5524.04/5942.38

HOME

BLAKIT

1963

CALICO BEDDING SETS

- Art.41241/0 (Single duvet cover 215*153 cm, sheet 220*145 cm, pillowcase 70*70 cm)
- Art.41242/0 (Single duvet cover 215*153 cm, sheet 220*145 cm, pillowcase 50*70 cm)
- Art.41251/0 (Double duvet cover 215*175 cm, sheet 220*210 cm, pillowcase 70*70 cm)
- Art.41252/0 (Double duvet cover 215*175 cm, sheet 220*210 cm, pillowcase 50*70 cm)
- Art.41261/0 (Euro duvet cover 215*225 cm, sheet 220*240 cm, pillowcase 70*70 cm)
- Art.41262/0 (Euro duvet cover 215*225 cm, sheet 220*240 cm, pillowcase 50*70 cm)
- Art.41271/0 (Duet duvet cover 215*153 cm 2 pcs, sheet 220*240 cm, pillowcase 70*70 cm)
- Art.41272/0 (Duet duvet cover 215*153 cm 2 pcs, sheet 220*240 cm, pillowcase 50*70 cm)



4918.05/4579/107



6287.01/5938.04

HOME

BLAKIT

1963

CALICO BEDDING SETS

Art.41241/0 (Single duvet cover 215*153 cm, sheet 220*145 cm, pillowcase 70*70 cm)

Art.41242/0 (Single duvet cover 215*153 cm, sheet 220*145 cm, pillowcase 50*70 cm)

Art.41251/0 (Double duvet cover 215*175 cm, sheet 220*210 cm, pillowcase 70*70 cm)

Art.41252/0 (Double duvet cover 215*175 cm, sheet 220*210 cm, pillowcase 50*70 cm)

Art.41261/0 (Euro duvet cover 215*225 cm, sheet 220*240 cm, pillowcase 70*70 cm)

Art.41262/0 (Euro duvet cover 215*225 cm, sheet 220*240 cm, pillowcase 50*70 cm)

Art.41271/0 (Duet duvet cover 215*153 cm 2 pcs, sheet 220*240 cm, pillowcase 70*70 cm)

Art.41272/0 (Duet duvet cover 215*153 cm 2 pcs, sheet 220*240 cm, pillowcase 50*70 cm)



6339.02/5873.19



5916.01/4579.71

HOME

BLAKIT

1963

CALICO BEDDING SETS

Art.41241/0 (Single duvet cover 215*153 cm, sheet 220*145 cm, pillowcase 70*70 cm)

Art.41242/0 (Single duvet cover 215*153 cm, sheet 220*145 cm, pillowcase 50*70 cm)

Art.41251/0 (Double duvet cover 215*175 cm, sheet 220*210 cm, pillowcase 70*70 cm)

Art.41252/0 (Double duvet cover 215*175 cm, sheet 220*210 cm, pillowcase 50*70 cm)

Art.41261/0 (Euro duvet cover 215*225 cm, sheet 220*240 cm, pillowcase 70*70 cm)

Art.41262/0 (Euro duvet cover 215*225 cm, sheet 220*240 cm, pillowcase 50*70 cm)

Art.41271/0 (Duet duvet cover 215*153 cm 2 pcs, sheet 220*240 cm, pillowcase 70*70 cm)

Art.41272/0 (Duet duvet cover 215*153 cm 2 pcs, sheet 220*240 cm, pillowcase 50*70 cm)



5699.01/6550.03



6427.03/5926.53

HOME

BLAKIT

1963

CALICO BEDDING SETS

Art.41241/0 (Single duvet cover 215*153 cm, sheet 220*145 cm, pillowcase 70*70 cm)

Art.41242/0 (Single duvet cover 215*153 cm, sheet 220*145 cm, pillowcase 50*70 cm)

Art.41251/0 (Double duvet cover 215*175 cm, sheet 220*210 cm, pillowcase 70*70 cm)

Art.41252/0 (Double duvet cover 215*175 cm, sheet 220*210 cm, pillowcase 50*70 cm)

Art.41261/0 (Euro duvet cover 215*225 cm, sheet 220*240 cm, pillowcase 70*70 cm)

Art.41262/0 (Euro duvet cover 215*225 cm, sheet 220*240 cm, pillowcase 50*70 cm)

Art.41271/0 (Duet duvet cover 215*153 cm 2 pcs, sheet 220*240 cm, pillowcase 70*70 cm)

Art.41272/0 (Duet duvet cover 215*153 cm 2 pcs, sheet 220*240 cm, pillowcase 50*70 cm)



6209.02/5926.48



4522.19/4579.106

HOME

BLAKIT

1963

CALICO BEDDING SETS

Art.41241/0 (Single duvet cover 215*153 cm, sheet 220*145 cm, pillowcase 70*70 cm)

Art.41242/0 (Single duvet cover 215*153 cm, sheet 220*145 cm, pillowcase 50*70 cm)

Art.41251/0 (Double duvet cover 215*175 cm, sheet 220*210 cm, pillowcase 70*70 cm)

Art.41252/0 (Double duvet cover 215*175 cm, sheet 220*210 cm, pillowcase 50*70 cm)

Art.41261/0 (Euro duvet cover 215*225 cm, sheet 220*240 cm, pillowcase 70*70 cm)

Art.41262/0 (Euro duvet cover 215*225 cm, sheet 220*240 cm, pillowcase 50*70 cm)

Art.41271/0 (Duet duvet cover 215*153 cm 2 pcs, sheet 220*240 cm, pillowcase 70*70 cm)

Art.41272/0 (Duet duvet cover 215*153 cm 2 pcs, sheet 220*240 cm, pillowcase 50*70 cm)



5715.01/5947.09



6311.03/5873.16

HOME

BLAKIT

1963

CALICO BEDDING SETS

Art.41241/0 (Single duvet cover 215*153 cm, sheet 220*145 cm, pillowcase 70*70 cm)

Art.41242/0 (Single duvet cover 215*153 cm, sheet 220*145 cm, pillowcase 50*70 cm)

Art.41251/0 (Double duvet cover 215*175 cm, sheet 220*210 cm, pillowcase 70*70 cm)

Art.41252/0 (Double duvet cover 215*175 cm, sheet 220*210 cm, pillowcase 50*70 cm)

Art.41261/0 (Euro duvet cover 215*225 cm, sheet 220*240 cm, pillowcase 70*70 cm)

Art.41262/0 (Euro duvet cover 215*225 cm, sheet 220*240 cm, pillowcase 50*70 cm)

Art.41271/0 (Duet duvet cover 215*153 cm 2 pcs, sheet 220*240 cm, pillowcase 70*70 cm)

Art.41272/0 (Duet duvet cover 215*153 cm 2 pcs, sheet 220*240 cm, pillowcase 50*70 cm)



6328.04/5926.65



5281.01/5926.55

HOME

BLAKIT

1963

CALICO BEDDING SETS

Art.41241/0 (Single duvet cover 215*153 cm, sheet 220*145 cm, pillowcase 70*70 cm)

Art.41242/0 (Single duvet cover 215*153 cm, sheet 220*145 cm, pillowcase 50*70 cm)

Art.41251/0 (Double duvet cover 215*175 cm, sheet 220*210 cm, pillowcase 70*70 cm)

Art.41252/0 (Double duvet cover 215*175 cm, sheet 220*210 cm, pillowcase 50*70 cm)

Art.41261/0 (Euro duvet cover 215*225 cm, sheet 220*240 cm, pillowcase 70*70 cm)

Art.41262/0 (Euro duvet cover 215*225 cm, sheet 220*240 cm, pillowcase 50*70 cm)

Art.41271/0 (Duet duvet cover 215*153 cm 2 pcs, sheet 220*240 cm, pillowcase 70*70 cm)

Art.41272/0 (Duet duvet cover 215*153 cm 2 pcs, sheet 220*240 cm, pillowcase 50*70 cm)



6328.04/5926.65



5668.01/4579.89

HOME

BLAKIT

1963

CALICO BEDDING SETS

Art.2380/0

(Single duvet cover 215*153 cm, sheet 220*145 cm, 70*70 cm 1 pc)



5755.01



6400.01



6266.04

COMMERCIAL OFFER

— HOME —

BLAKIT

— 1963 —

**BEDDING SETS FROM
BOILED COTTON**

BEDDING SETS FROM BOILED COTTON

ITEM	SIZE AND COMPOSITION	PRICE, EUR
4843	SINGLE BEDDING SET : (DUVET COVER 215cm*175 cm, SHEET 200 cm*160cm*25 cm, PILLOW CASE 2X50cm*70 cm)	
4844	DOUBLE BEDDING SET: (DUVET COVER 225cm*215 cm, SHEET 200 cm*160cm*25 cm, PILLOW CASE 2X50cm*70 cm)	
4845	DUET BEDDING SET: (DUVET COVER 215cm*153 cm, SHEET 200 cm*160cm*25 cm, PILLOW CASE 2X50cm*70 cm)	



Boiled cotton is a unique type of fabric with a specific finishing that makes it extraordinary soft, pleasant to the touch and durable. Breathable and moisture absorbent, boiled cotton is ideal for usage in warm seasons.

Bedding sets from boiled cotton is a good choice for a comfy sleep

Such material breathes well and is very gentle, which is especially important in the warm season.



HOME

BLAKIT

1963

BOILED COTTON

FABRIC ARTICLE # 13291 (3724)

COTTON FABRIC FOR BEDDING

WIDTH: 220CM

120 GSM

PLAIN WEAVE



13-4809



14-3710



16-4414

100%
BOILED
COTTON

DOES NOT
REQUIRE
IRONING



18-0627



17-1230



17-6323

FITTED
SHEET

BOILED COTTON



The art of creating fabrics



THE HISTORY OF THE COMPANY

Kamvol is one of the largest manufacturers of high-quality exclusive wool fabrics in the CIS and Europe.

Since 1955, our company has been constantly developing.

MAIN PRODUCTION:
Belarus, Minsk, Mayakovsky 176



NOWADAYS JSC KAMVOL IS..



> **112,000** sq meters of production space;



> **300** fabric articles;



> **2,000** color nozzles in the industrial collection;



the ability to produce more than **6 million** linear meters per year;



a wide range of products.



The background features a dark green, textured fabric-like pattern. A solid dark green horizontal band runs across the middle, containing the text and decorative lines. Two thin, light-colored horizontal lines with square end caps are positioned above and below the text within this band.

FABRICS FOR DEPARTMENTAL INSTITUTIONS

АРТИКУЛ/ARTICLE 02С55

РИСУНОК/COLOUR 575-1

СОСТАВ/COMPOSITION

Шерсть/Wool — **67%**, ПЭ/PES — **33%**

Ширина/Width — **152 см/cm**

Вес/Weight — **317 гм2/gm2**

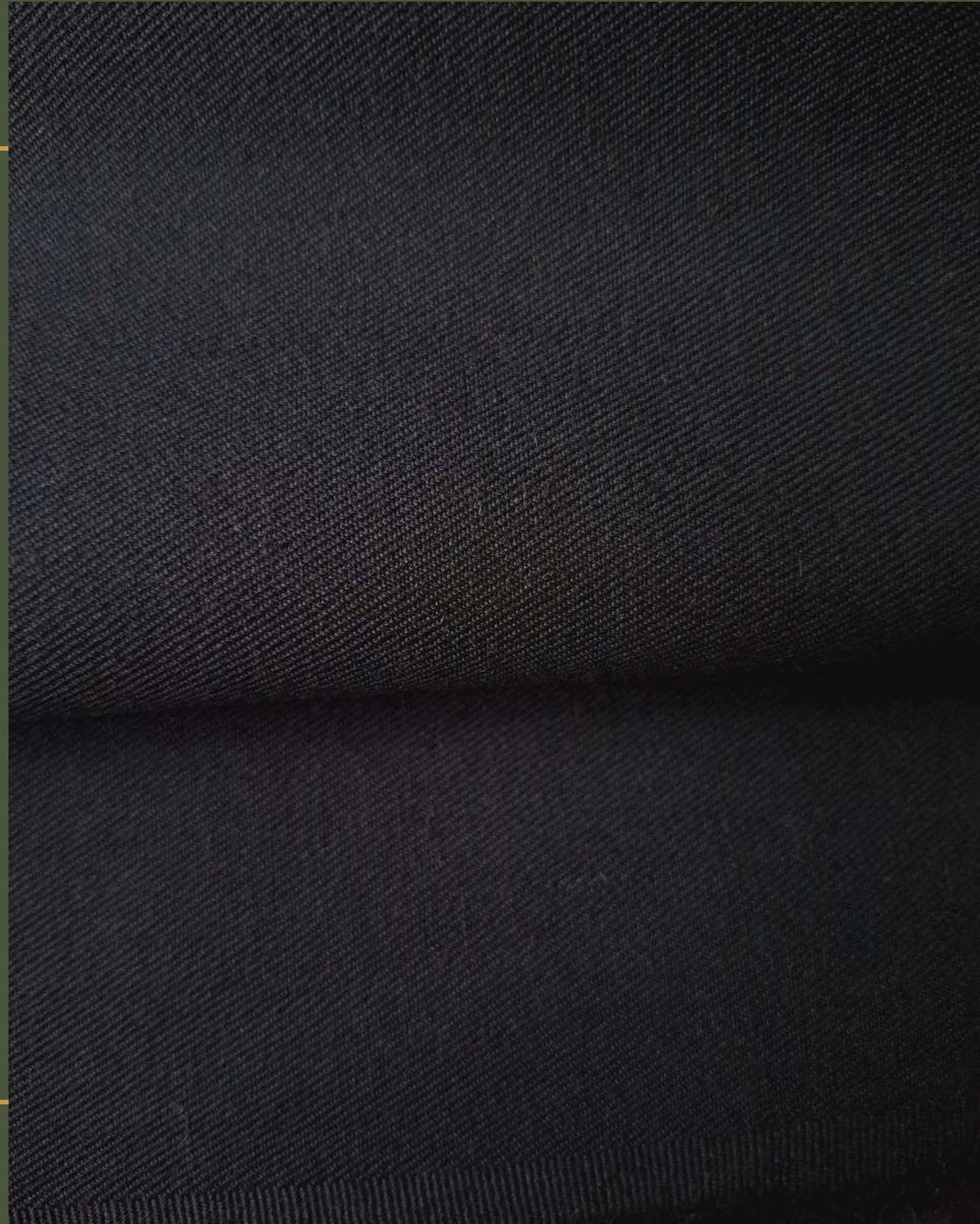

АРТИКУЛ/ARTICLE 02С55

РИСУНОК/COLOUR 15-2

СОСТАВ/COMPOSITION

Шерсть/Wool — **67%**, ПЭ/PES — **33%**

Ширина/Width — **152 см/cm**

Вес/Weight — **317 гм2/gm2**

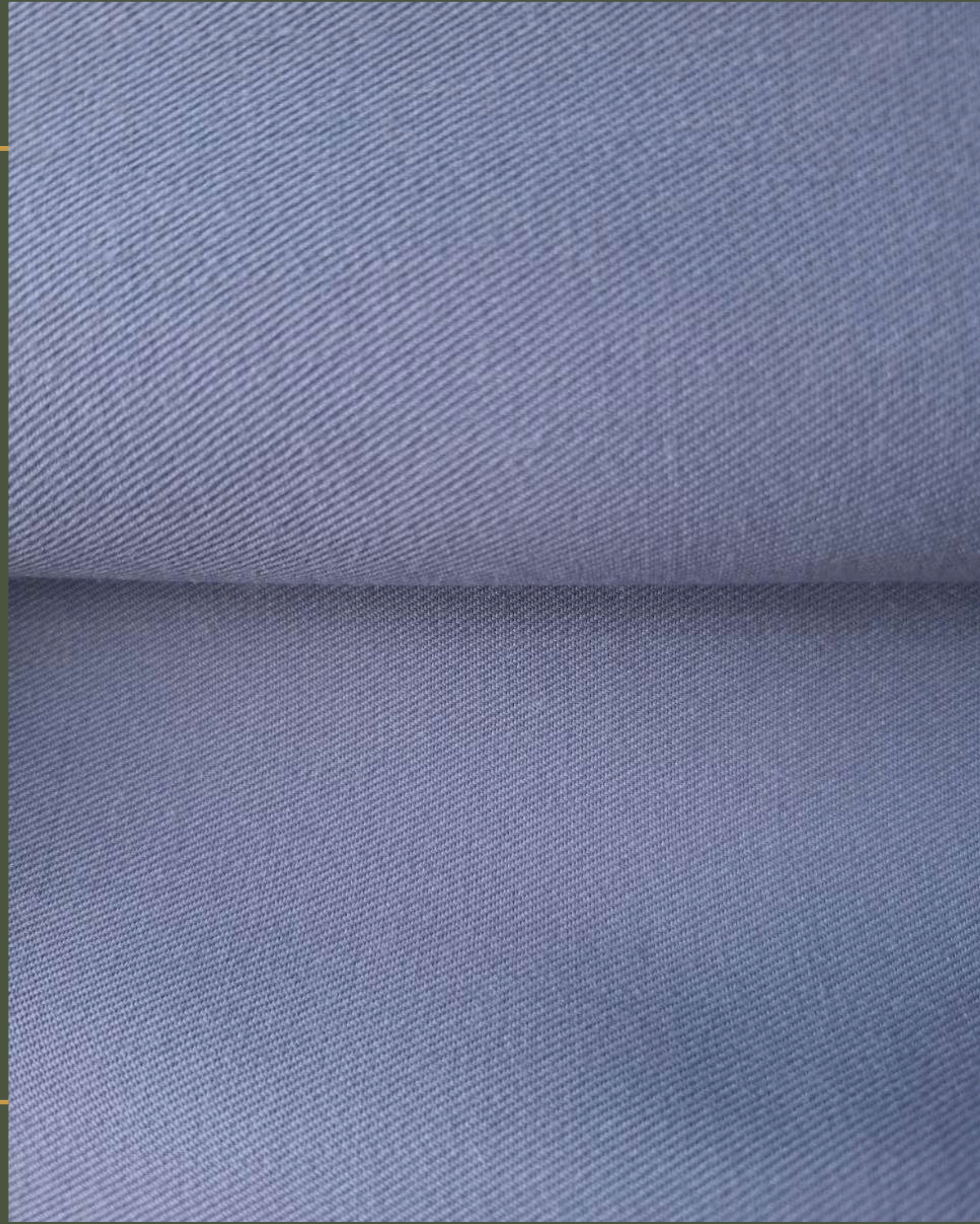

АРТИКУЛ/ARTICLE 03С46

РИСУНОК/COLOUR 11-2

СОСТАВ/COMPOSITION

Шерсть/Wool — **45%**, ПЭ/PES — **55%**

Ширина/Width — **152 см/см**

Вес/Weight — **257 гм2/гм2**



АРТИКУЛ/ARTICLE 03С46

РИСУНОК/COLOUR 773-11

СОСТАВ/COMPOSITION

Шерсть/Wool — **45%**, ПЭ/PES — **55%**

Ширина/Width — **152 см/cm**

Вес/Weight — **257 гм2/gm2**



АРТИКУЛ/ARTICLE 05С54

РИСУНОК/COLOUR 4-1

СОСТАВ/COMPOSITION

Шерсть/Wool — **45%**, ПЭ/PES — **55%**

Ширина/Width — **152 см/см**

Вес/Weight — **288 гм2/гм2**



АРТИКУЛ/ARTICLE 05С54

РИСУНОК/COLOUR 473-1

СОСТАВ/COMPOSITION

Шерсть/Wool — **45%**, ПЭ/PES — **55%**

Ширина/Width — **152 см/cm**

Вес/Weight — **288 гм2/gm2**



АРТИКУЛ/ARTICLE 05С55

РИСУНОК/COLOUR 3-2

СОСТАВ/COMPOSITION

Шерсть/Wool — **66%**, ПЭ/PES — **34%**

Ширина/Width — **152 см/cm**

Вес/Weight — **300 гм2/gm2**



АРТИКУЛ/ARTICLE 05С55

РИСУНОК/COLOUR 4-2

СОСТАВ/COMPOSITION

Шерсть/Wool — **66%**, ПЭ/PES — **34%**

Ширина/Width — **152 см/cm**

Вес/Weight — **300 гм2/gm2**



АРТИКУЛ/ARTICLE 05С55

РИСУНОК/COLOUR 7-2

СОСТАВ/COMPOSITION

Шерсть/Wool — **66%**, ПЭ/PES — **34%**

Ширина/Width — **152 см/cm**

Вес/Weight — **300 гм2/gm2**



АРТИКУЛ/ARTICLE 07C42

РИСУНОК/COLOUR 8-2

СОСТАВ/COMPOSITION

Шерсть/Wool — **66%**, ПЭ/PES — **34%**

Ширина/Width — **152 см/cm**

Вес/Weight — **300 гм2/gm2**



АРТИКУЛ/ARTICLE 07C42

РИСУНОК/COLOUR 749-1

СОСТАВ/COMPOSITION

Шерсть/Wool — **33%**, ПЭ/PES — **67%**

Ширина/Width — **152 см/cm**

Вес/Weight — **285 гм2/gm2**

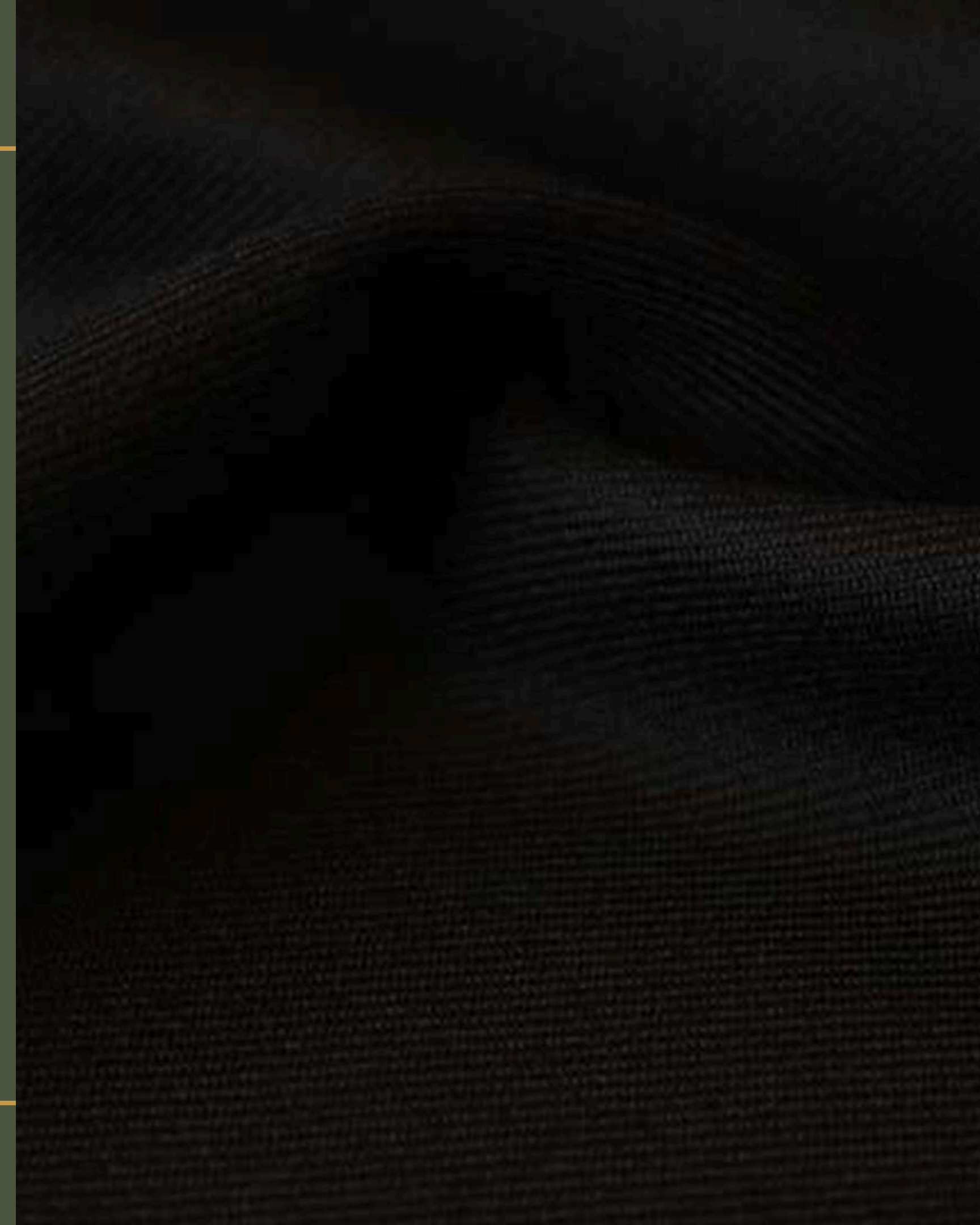

АРТИКУЛ/ARTICLE 07C42

РИСУНОК/COLOUR 762-1

СОСТАВ/COMPOSITION

Шерсть/Wool — **33%**, ПЭ/PES — **67%**

Ширина/Width — **152 см/cm**

Вес/Weight — **285 гм2/gm2**



АРТИКУЛ/ARTICLE 07С63

РИСУНОК/COLOUR 620-1

СОСТАВ/COMPOSITION

Шерсть/Wool — **45%**, ПЭ/PES — **55%**

Ширина/Width — **152 см/cm**

Вес/Weight — **270 гм2/gm2**

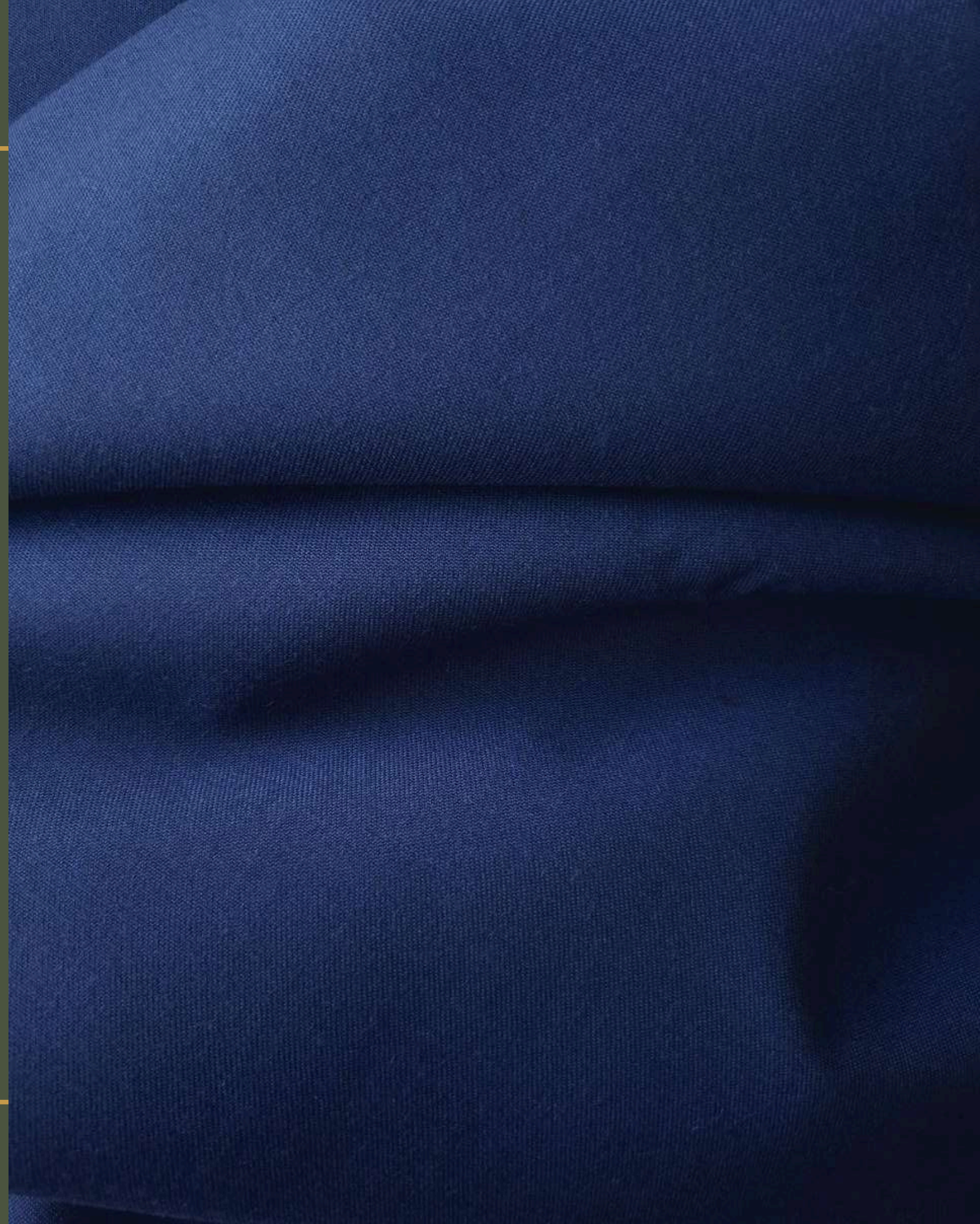

АРТИКУЛ/ARTICLE 07С70

РИСУНОК/COLOUR 5-1

СОСТАВ/COMPOSITION

Шерсть/Wool — **43%**, ПЭ/PES — **55%**,

Лайкра/Lycra — **2%**

Ширина/Width — **152 см/см**

Вес/Weight — **210 гм2/гм2**



АРТИКУЛ/ARTICLE 07С70

РИСУНОК/COLOUR 31-5

СОСТАВ/COMPOSITION

Шерсть/Wool — **43%**, ПЭ/PES — **55%**,

Лайкра/Lycra — **2%**

Ширина/Width — **152 см/см**

Вес/Weight — **210 гм2/гм2**



АРТИКУЛ/ARTICLE 09C45

РИСУНОК/COLOUR 3-2

СОСТАВ/COMPOSITION

Шерсть/Wool — **44%**, ПЭ/PES — **54%**,

Лайкра/Lycra — **2%**

Ширина/Width — **152 см/см**

Вес/Weight — **250 гм2/гм2**



АРТИКУЛ/ARTICLE 09C45

РИСУНОК/COLOUR 6-2

СОСТАВ/COMPOSITION

Шерсть/Wool — **44%**, ПЭ/PES — **54%**,

Лайкра/Lycra — **2%**

Ширина/Width — **152 см/см**

Вес/Weight — **250 гм2/гм2**



АРТИКУЛ/ARTICLE 09C45

РИСУНОК/COLOUR 7-2

СОСТАВ/COMPOSITION

Шерсть/Wool — **44%**, ПЭ/PES — **54%**,

Лайкра/Lycra — **2%**

Ширина/Width — **152 см/см**

Вес/Weight — **250 гм2/гм2**

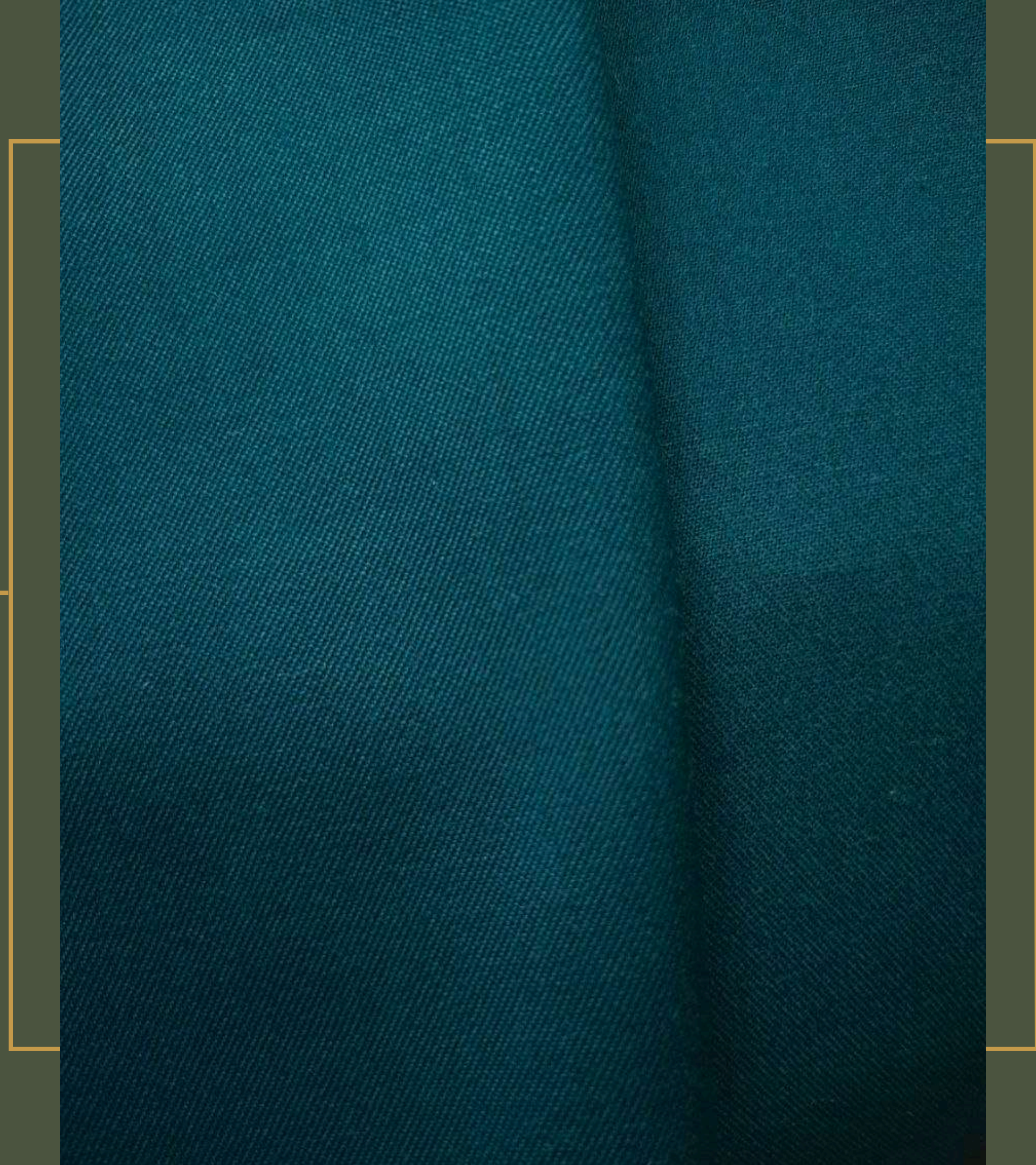

АРТИКУЛ/ARTICLE 10С26

РИСУНОК/COLOUR 15-2

СОСТАВ/COMPOSITION

Шерсть/Wool — **45%**, ПЭ/PES — **55%**,

Ширина/Width — **238 см/cm**

Вес/Weight — **238 гм2/gm2**



АРТИКУЛ/ARTICLE 10С26

РИСУНОК/COLOUR 8-2

СОСТАВ/COMPOSITION

Шерсть/Wool — **45%**, ПЭ/PES — **55%**,

Ширина/Width — **154 см/cm**

Вес/Weight — **238 гм2/gm2**



АРТИКУЛ/ARTICLE 13С27

РИСУНОК/COLOUR 1-2

СОСТАВ/COMPOSITION

Шерсть/Wool — **65%**, ПЭ/PES — **35%**,

Ширина/Width — **152 см/см**

Вес/Weight — **280 гм2/гм2**

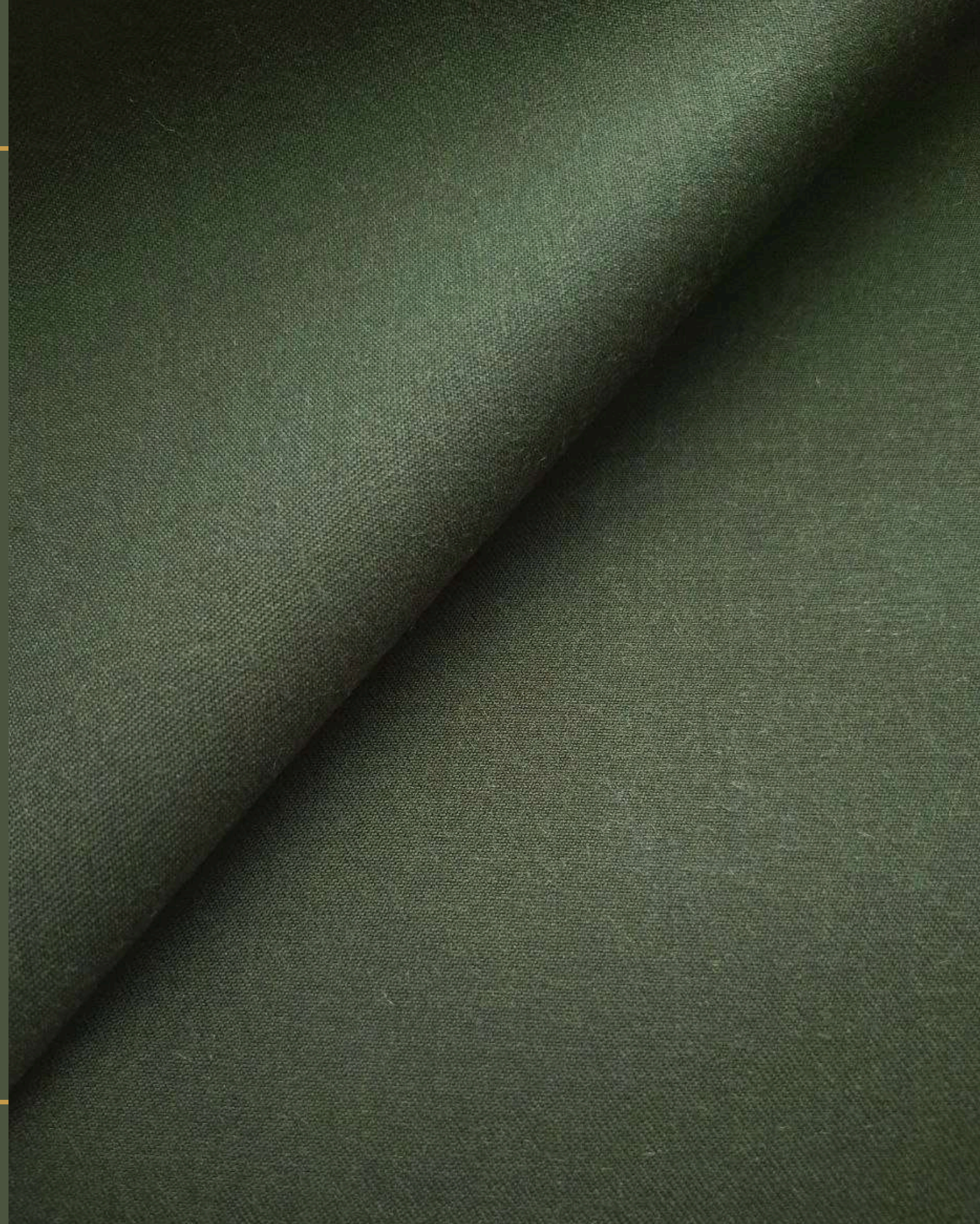

АРТИКУЛ/ARTICLE 13С27

РИСУНОК/COLOUR 476-1

СОСТАВ/COMPOSITION

Шерсть/Wool — **65%**, ПЭ/PES — **35%**,

Ширина/Width — **152 см/cm**

Вес/Weight — **280 гм2/gm2**



АРТИКУЛ/ARTICLE 13С27

РИСУНОК/COLOUR 872-1

СОСТАВ/COMPOSITION

Шерсть/Wool — **65%**, ПЭ/PES — **35%**,

Ширина/Width — **152 см/cm**

Вес/Weight — **280 гм2/gm2**



АРТИКУЛ/ARTICLE 14С42

РИСУНОК/COLOUR 760-1

СОСТАВ/COMPOSITION

Шерсть/Wool — **30%**, ПА/РА — **70%**,

Ширина/Width — **152 см/см**

Вес/Weight — **240 гм2/гм2**

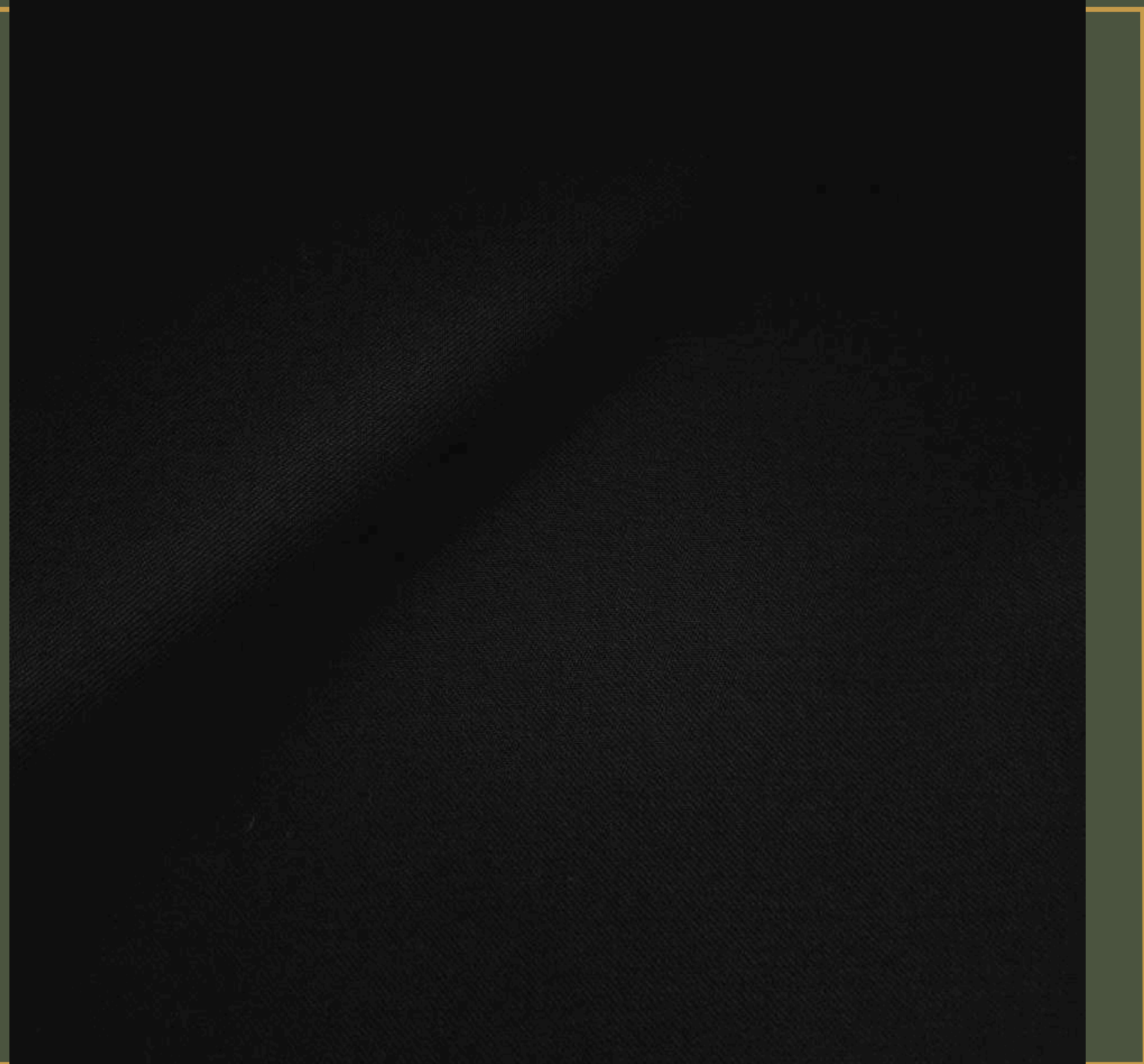

АРТИКУЛ/ARTICLE 20С82

РИСУНОК/COLOUR 5-3

СОСТАВ/COMPOSITION

Шерсть/Wool — **44%**, ПЭ/PES — **54%**,

Лайкра/Lycra — **2%**

Ширина/Width — **152 см/см**

Вес/Weight — **223 гм2/гм2**

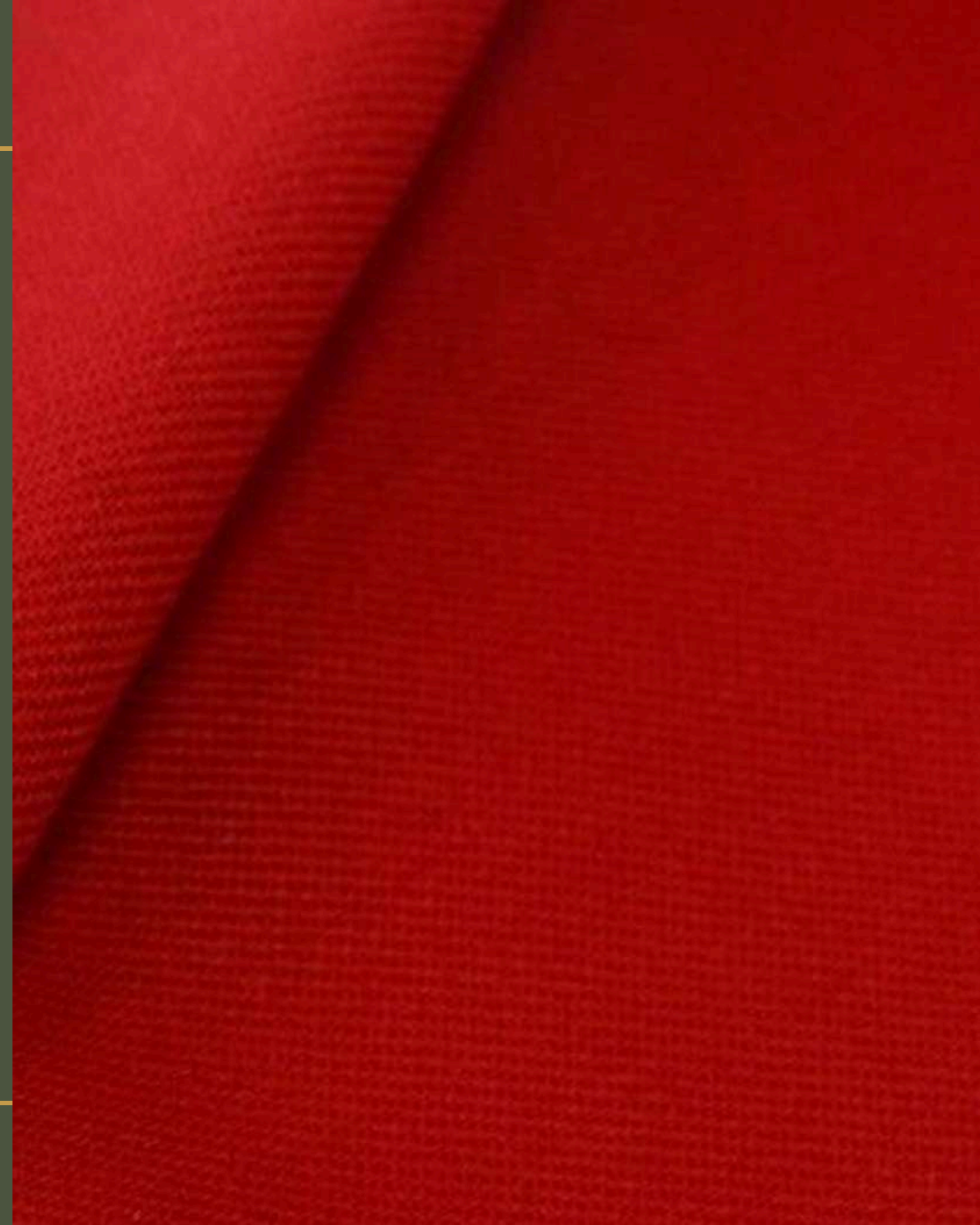

АРТИКУЛ/ARTICLE 20С82

РИСУНОК/COLOUR 6-3

СОСТАВ/COMPOSITION

Шерсть/Wool — **44%**, ПЭ/PES — **54%**,

Лайкра/Lycra — **2%**

Ширина/Width — **152 см/cm**

Вес/Weight — **223 гм2/gm2**



АРТИКУЛ/ARTICLE 20С82

РИСУНОК/COLOUR 6-3

СОСТАВ/COMPOSITION

Шерсть/Wool — **44%**, ПЭ/PES — **54%**,

Лайкра/Lycra — **2%**

Ширина/Width — **152 см/см**

Вес/Weight — **223 гм2/гм2**

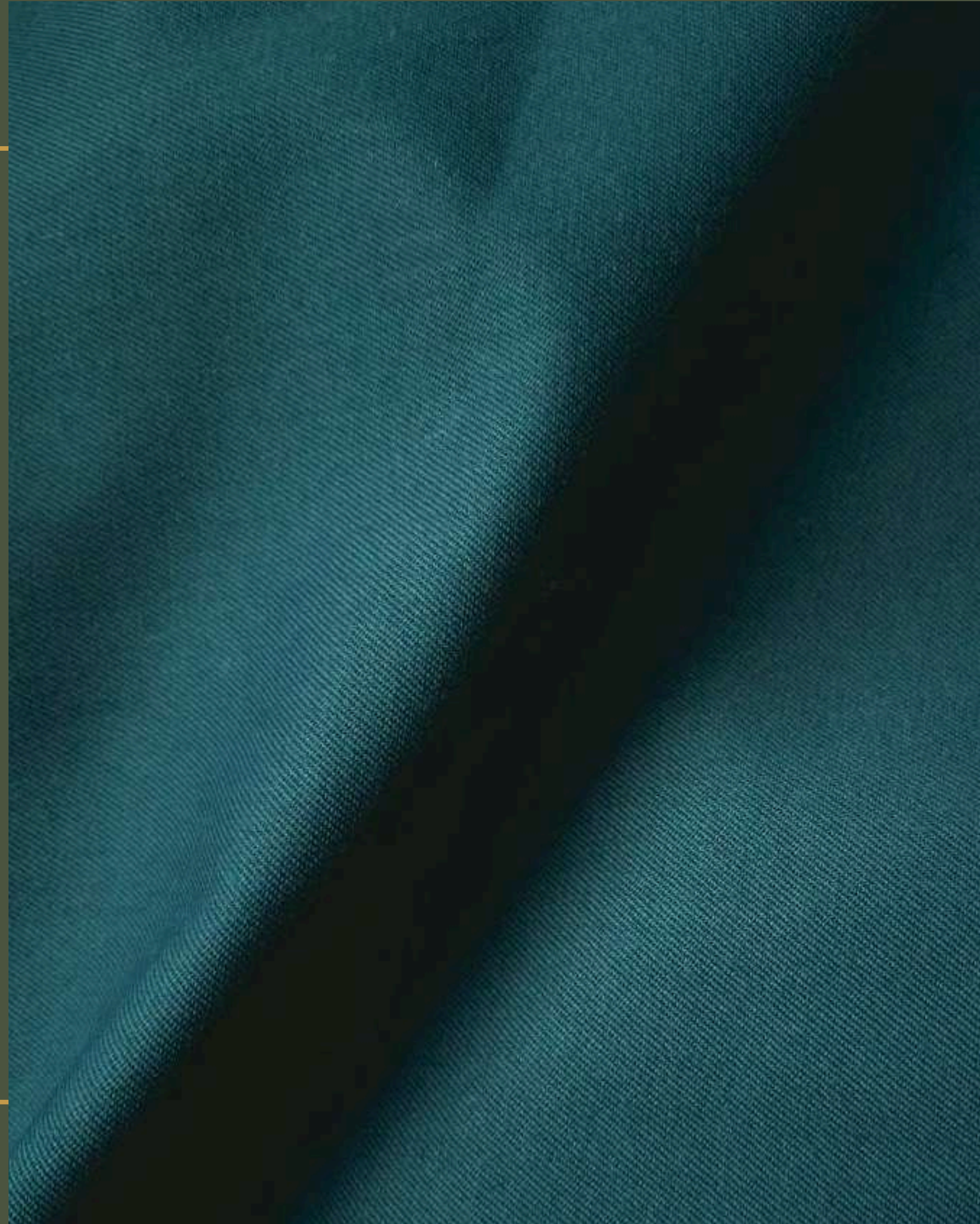

АРТИКУЛ/ARTICLE 20С82

РИСУНОК/COLOUR 10-3

СОСТАВ/COMPOSITION

Шерсть/Wool — **44%**, ПЭ/PES — **54%**,

Лайкра/Lycra — **2%**

Ширина/Width — **152 см/см**

Вес/Weight — **223 гм2/гм2**

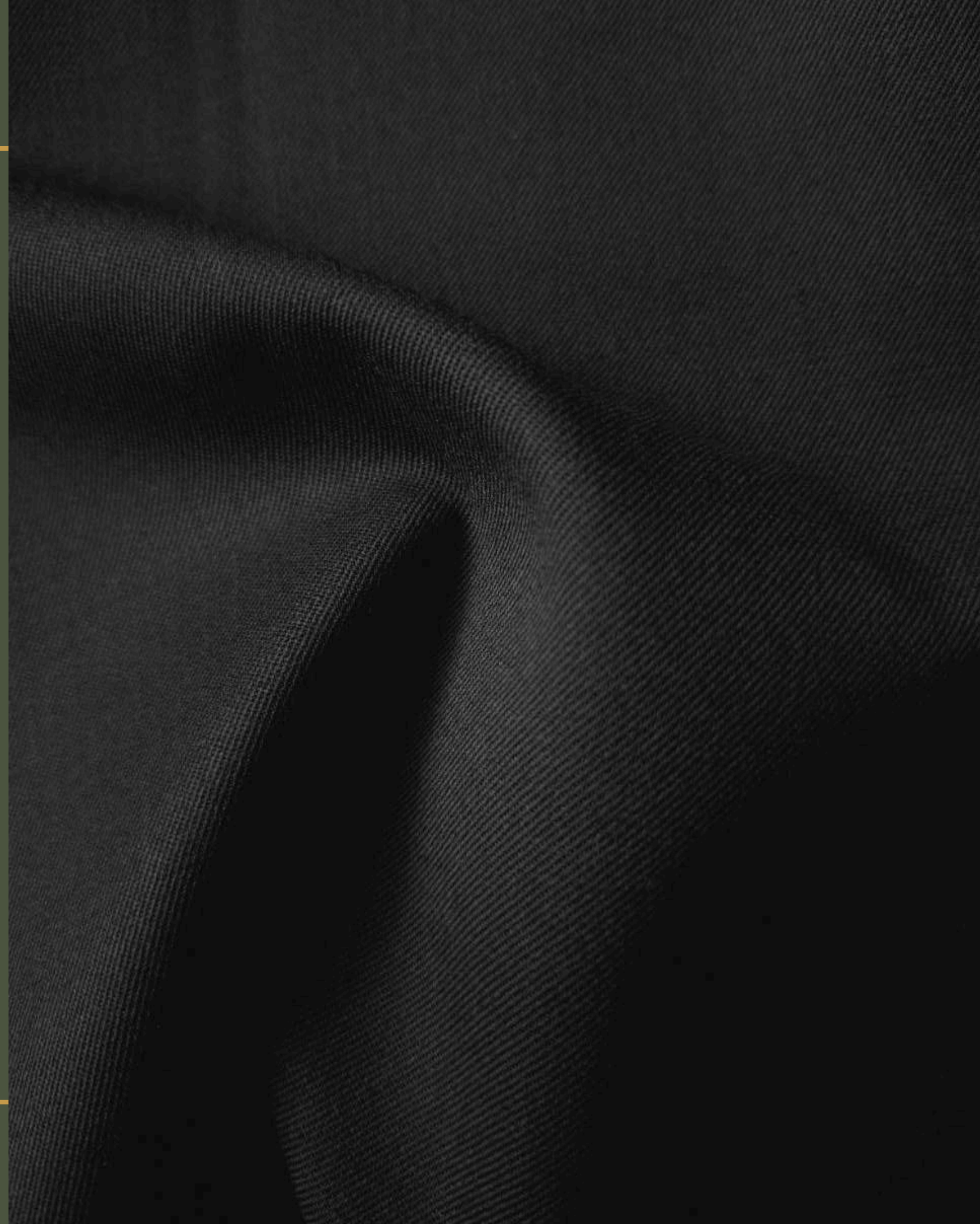

АРТИКУЛ/ARTICLE 23С89

РИСУНОК/COLOUR 1-3

СОСТАВ/COMPOSITION

Шерсть/Wool — **40%**, ПЭ/PES — **60%**,

Ширина/Width — **152 см/cm**

Вес/Weight — **290 гм2/gm2**





JOIN OUR PARTNERSHIP

JSC «KAMVOL» ADDRESS:

176, Mayakovskogo str., 220028, Minsk, Republic of Belarus.

CONTACTS:

 **SALES:** land +375 17 377 20 08
+375 17 374 14 00

 sales@kamvol.by

 [kamvol](https://www.instagram.com/kamvol)

 [@kamvol1955](https://www.telegram.com/@kamvol1955)



www.kamvol.by